

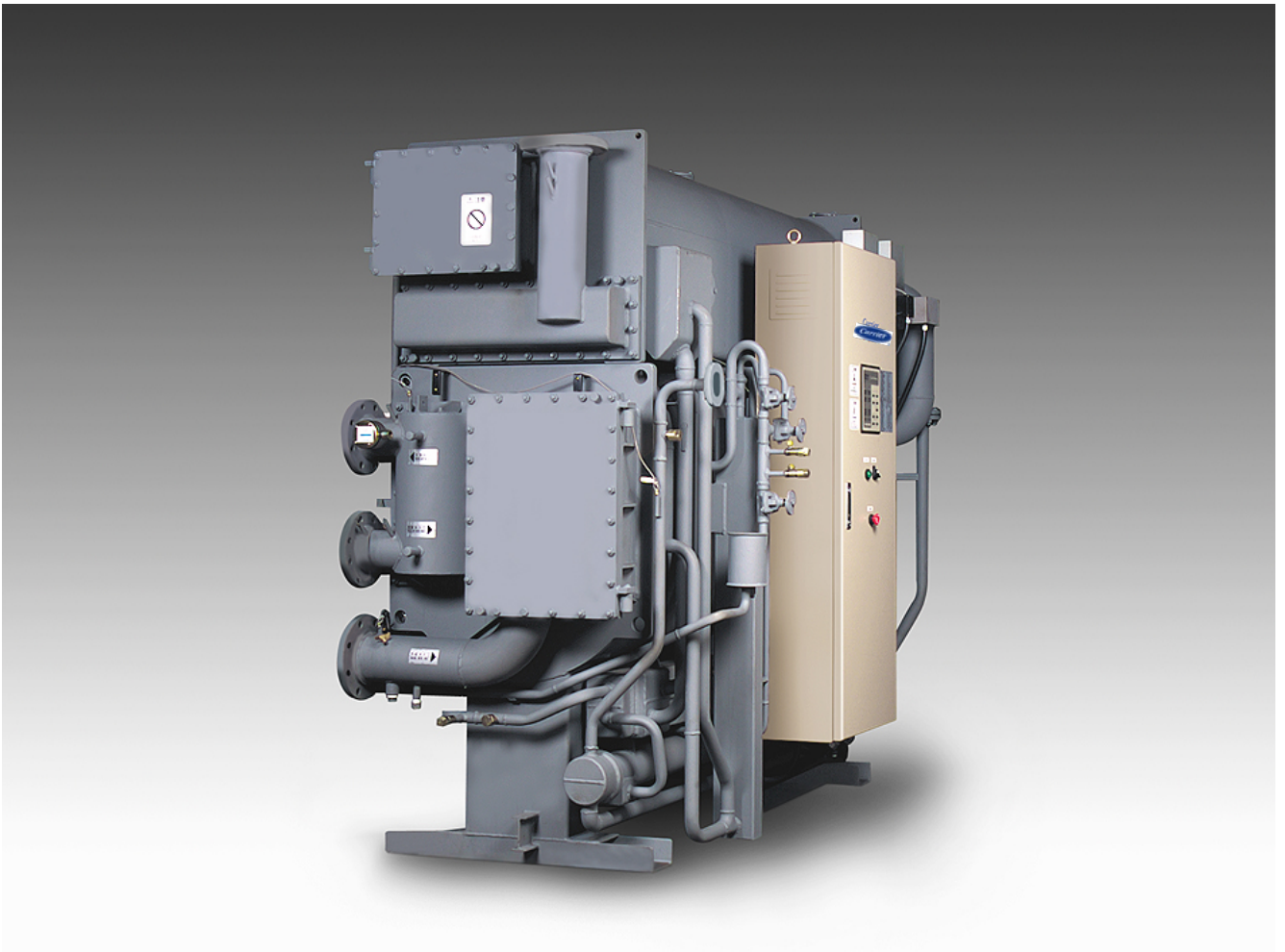

OPERATION MANUAL
Absorption Chiller
16LJ-A Series



Original language
814-6-0510-258-00-0

NOTES TO USERS

Thank you for purchasing Carrier Absorption Chiller.
Before operating the Chiller, please read this manual thoroughly.

Please utilize the Chiller to its optimum performance by following recommended daily maintenance and handling, and periodic service.

If you need any information about maintenance contract or any other inquiries, please contact Carrier service agent.

DECLARATION OF CONFORMITY < for CE marking model >

This product is marked " CE " as it satisfied EEC Directive No. 2006/42/EC, 2004/108/EC, 97/23/EC, 90/396/EEC and conforms with following standards.

This declaration will become void in case of misuse and/or from non observance though partial of Manufacturer's installation and/or operating instructions.

Class and group description (EN 55011, clause 5.1)

This is group 1, class A product according to EN 55011. This means that this product does not generate and/or use intentionally radio-frequency energy, in the form of electromagnetic radiation, inductive and/or capacitive coupling, for the treatment of material or inspection / analysis purpose and that it is suitable for use in all establishments other than domestic and those directly connected to a low voltage power supply network which supplies buildings used for domestic purposes.

Statement for Class A Equipment (EN 55011, clause 5.3)

This is a class A product. There may be potential difficulties in ensuring electromagnetic compatibility in environments other than industrial, due to conducted as well as radiated disturbances.

Cable Specification and Equipment Orientation (EN 55011, clause 7.5.2 and EN 61000-6-2)

Refer to the "Field wiring" section of the Installation manual.

CE Marking and Apparatus Identification (2006/42/EC, clause 16.2 and 2004/108/EC, clause 8.1)

There are printed on the nameplate of the chiller control panel.

Name and Address of Manufacture

Refer to the document of Declaration of conformity.

Statement for Equipment for witch Compliance with the Protection Requirements is not ensured in Residential Areas (EMC Directive 2004/108/EC, clause 9.4)

- This product must not be used in residential areas.
- This product may cause interference if used in residential areas. Such use must be avoided unless the user takes special measures to reduce electromagnetic emissions to prevent interference to the reception of radio and television broadcasts.

UL CERTIFICATION < for UL marking model >

This product has met the necessary design and construction qualifications for certification per Underwriters' Laboratories. Each machine carries a UL listing and is labeled accordingly.

PRODUCT PROFILE

- (1) Excellent for peak shaving during high electrical demand periods.
- (2) Designed to provide chilled water from waste heat sources, generated from industrial processes and cogeneration systems.
- (3) Allows diversification of critical cooling requirements. Critical cooling loads are met with minimal electrical power input with a hot water-fired chiller.
- (4) Allows for smaller generator set installation be utilized since the electrical load associated with an absorption chiller is minimal when compared to an electric chiller.
- (5) Ozone safe, CFC free. Cooling requirements are met without chlorine based refrigerants.
- (6) Reduces effectors to global warming. Minimizes global impact by greatly reducing electricity consumption and eliminating the use of greenhouse gases.
- (7) Environment: Molybdate solution inhibitor is used with no impact on environment.
- (8) Low noise and vibration. The absorption chiller dose not utilize a large motor-compressor, and this leads to quiet, trouble-free operation.
- (9) Small footprint saves facility space.

USE OF PRODUCT

Absorption Chiller is air conditioning equipment achieving comfortable space, energy saving, and economic efficiency. It has been used in office buildings, hotels, department stores, hospitals, schools, convention centers, government building, etc.

Note: The contents of this manual are subject to change without notice.

*** * * * *** **Absorption Chiller Operation Manual** *** * * * ***



Table of Contents

1. SAFETY PRECAUTIONS -----	1-1
2. OPERATING PRECAUTIONS -----	2-1
2-1. PRECAUTIONS WITHIN 1 HOUR AFTER THE CHILLER SHUTDOWN -----	2-2
2-2. PRECAUTIONS AFTER THE CHILLER STOP -----	2-2
2-3. CONTROL PROCEDURES FOR AUXILIARY EQUIPMENTS -----	2-3
2-4. ACTION IN CASE OF THE POWER FAILURE -----	2-5
2-5. NOISE DATA -----	2-5
3. ILLUSTRATION	
3-1. DETAIL OF TYPICAL CHILLER/HEATER -----	3-1
3-2. TYPICAL CONTROL PANEL -----	3-3
3-3. FLOWCHART OF CHILLER AND FUNCTION OF EACH SECTION -----	3-4
4. OPERATING INSTRUCTIONS	
4-1. TURN ON THE MAIN CIRCUIT BREAKER -----	4-1
4-2. DESCRIPTION OF KEYS AND THEIR FUNCTIONS -----	4-2
4-3. OPERATION -----	4-3
4-4. HOW TO CHANGE THE INDICATION ON DATA DISPLAY -----	4-6
4-5. HOW TO CHANGE THE INDICATION AND THE SETTING POINT -----	4-8
4-6. MAINTENANCE MESSAGE -----	4-9
4-7. ALARM INDICATIONS AND ACTIONS TO BE TAKEN -----	4-10
5. MAINTENANCE	
5-1. DAILY INSPECTION -----	5-1
5-2. PERIODIC MAINTENANCE -----	5-1
5-3. WATER TREATMENT -----	5-3
5-4. RECOMMENDED SCHEDULE FOR MAINTENANCE AND REPLACEMENT OF MAIN COMPONENTS -----	5-7
6. MAINTENANCE CONTRACT	
6-1. ANNUAL MAINTENANCE CONTRACT -----	6-1
6-2. INSPECTION REPORT -----	6-1
6-3. WARRANTY -----	6-1



1. SAFETY PRECAUTIONS



To avoid harm to the operator and others, and to protect own asset, be sure to follow the instructions and requirements on safety described in this manual.

We explain about a harm or damage if a chiller is used with mistaken usage ignoring these precautions.

	DANGER	Failure to observe this instruction must result in serious injury or death.
	WARNING	Failure to observe this instruction may cause serious injury or death.
	CAUTION	Failure to observe this instruction may result in impediment or damage to the product or the property.













Symbol conventions

	Refer to advice that denotes caution.
	Refer to something that is prohibited.
	Refer to advice that must be observed.

		DANGER	
<p>STOP OPERATION IN CASE OF FIRE, EARTHQUAKE OR POSSIBLE THUNDERBOLT</p> <p>Stop the operation in case of a fire, earthquake or when there is likely to be a thunderbolt, to prevent a fire or electric shock.</p>	<p>ONLY AUTHORIZED PERSONNEL SHOULD OVERHAUL THE CHILLER</p> <p>Only those who are authorized should overhaul the chiller. Incomplete service could result in electric shock or a fire.</p>		
 Must be observed	 Do not disassemble		



WARNING

<p>TURN OFF THE BREAKER BEFORE CLEANING AND CHECKING</p> <p>Always turn off the breaker before cleaning and checking the cooling tower fan, water pumps, or others linking to the chiller, to provide protection from electric shock or possible injury by the rotating part.</p> <p> Must be observed</p>	<p>DO NOT TOUCH THE PARTS INSIDE THE CONTROL PANEL DO NOT TOUCH THE CONTROL PANEL SWITCH WITH WET HANDS</p> <p>Do not touch the parts inside the control panel to avoid electric shock. Do not touch the switch inside the control panel with wet hand to avoid electric shock.</p> <p> Do not touch</p>
<p>KEEP FLAMMABLES AWAY FROM THE CHILLER</p> <p>Do not place any flammables (gasoline, thinner, etc.) close to the chiller, flue, chimney and oil tank to prevent a fire.</p> <p> Prohibited</p>	<p>DO NOT TOUCH ANY ROTATING PART</p> <p>Keep away your fingers and/or clothes from any rotating part of fan or pump to avoid possible injury.</p> <p> Prohibited</p>
<p>USE THE CORRECT POWER SUPPLY</p> <p>The rating indicated on the name plate of the chiller. Use of the power other than specified here may cause a fire or electric shock.</p> <p> Prohibited</p>	<p>CALL SPECIALISTS FOR SERVICE OR MAINTENANCE</p> <p>Call specialists for service or maintenance. Wrong service /maintenance may cause electric shock, a fire or burn.</p> <p> Must be observed</p>
<p>NEVER CHANGE THE SET VALUE</p> <p>Never change the set value of the safety and/or protective devices. Wrong setting may damage the chiller or cause a fire.</p> <p> Prohibited</p>	<p>ONLY AUTHORIZED PERSONNEL SHOULD REMOVE OR REPAIR THE CHILLER</p> <p>Any relocation or moving of the chiller should be done by authorized personnel only. Incomplete work could result in a vacuum break, a solution leak, electric shock or a fire.</p> <p> Must be observed</p>
<p>ONLY AUTHORIZED PERSONNEL SHOULD DISPOSE OF THE CHILLER</p> <p>To dispose of the chiller, contact the local specialist. Any defective disposal may cause metal corrosion or skin disease by absorbent leak.</p> <p> Must be observed</p>	<p>ONLY AUTHORIZED PERSONNEL SHOULD PERFORM THE WIRING</p> <p>Only those who are authorized should perform the wiring. Incomplete work could result in a fire.</p> <p> Must be observed</p>
<p>DO NOT CUT THE POWER SUPPLY WHILE THE CHILLER IS STOPPING</p> <p>Chiller is watching the vacuum level while it is stopping.</p> <p> Prohibited</p>	<p>USE PARTS THAT ARE SPECIFIED</p> <p>Use parts that are specified, or it may cause a malfunction.</p> <p> Prohibited</p>

**DO NOT OPERATE COOLING WATER PUMP
WITHIN 1 HOUR AFTER CHILLER STOPS
COMPLETELY**

There is a possibility of chilled water freezing by the remaining cooling capacity.



Prohibited

WIRE EACH INTERLOCK

Be sure to wire the interlock for chilled water pump, cooling water pump and ventilation fan.



**Must be
observed**



CAUTION

DO NOT PLACE HEAVY OBJECTS ON THE CHILLER OR THE CONTROL PANEL

Do not place heavy objects on the chiller or the control panel to avoid possible injury caused by falling.



Prohibited

DO NOT CLIMB UP THE CHILLER

Do not climb up the chiller to avoid nasty fall.



Prohibited

AUTHORIZED PERSONNEL ONLY

A notice, "For Authorized Personnel Only" must be affixed to the chiller to keep away unauthorized personnel from touching it. If this is anticipated, enclose the chiller with a protective fence. Misuse of the chiller may cause injury.



Prohibited

DO NOT POUR WATER OVER THE CHILLER OR THE CONTROL PANEL

Do not pour water over the chiller or the control panel to avoid electric shock.



Prohibited

OBSERVE THE SPECIFIED PRESSURE OF WATER

The specified pressure of chilled water, hot water and cooling water must strictly be observed. Incorrect pressure may cause spout or leak which may cause a short circuit or burn.



Must be observed

DO NOT TOUCH THE HIGH TEMPERATURE AREAS

Do not touch the high temperature areas. These areas are indicated by caution label. Please avoid touching on such areas to prevent burn.



Prohibited

STOP THE PURGE PUMP TO REPLACE OIL

Stop the purge pump when replacing oil to avoid possible injury by oil scattering.



Must be observed

MAINTAIN THE QUALITY OF CHILLED WATER, HOT WATER, COOLING WATER, MAKE UP WATER AND BOILER WATER

There is a possibility of tube corrosion due to water pollution or poor water quality. Contact a water treatment company.



Caution

ACTION AFTER THE POWER FAIL RECOVERY

The action is different with outage failure time and cooling mode. Check details by this manual.



Caution

2. OPERAING PRECAUTIONS

(1) Stop timing of auxiliary equipments

During the dilution cycle operation of the Chiller, the chilled water pump (both the primary side and the secondary side) and air handling unit must be operated for the necessary time. The Chiller has a little cooling capacity even if it is in the dilution cycle operation. Do not stop the air handling unit before the necessary time to prevent possible chilled water freezing.

Connect the operation signal wires from the chiller to the chilled water pump and cooling water pump. Each pump must be automatically operated by the chiller signal.

(2) Freeze protection of chilled water, hot water and cooling water

In winter, ensure that the chilled and cooling water in the pipes does not freeze during chiller shutdown.

There is a possibility of chilled water freezing by a remaining cooling capacity within 1 hour after the Chiller stops completely.

(3) Chilled water flow through the chiller

Don't flow chilled water over 40% of the rated value at the chiller starting. Otherwise, chiller will not start because it cannot check the flow switch contact switching from off to on.

(4) Temperature of cooling water during operation

Keep the cooling water entering temperature above 21°C / 69.8°F and above 24°C / 75.2°F for a process setting machine.

During the start-up process however, a lower temperature is allowable until the operating condition becomes normal.

If the chiller operates during intermediate season or in winter, provide an automatic three-way control valve to the bypass piping of cooling tower.

When the chiller operates during intermediate season or in winter, there is a possibility of safety stop with alarm in the case that cooling water inlet temperature does not reach the rated condition within 30 min. after starting chiller operation.

(5) Power supply during the shutdown period

Don't cut the power supply during the shutdown period.

Refer to "2-2.Precautions after the chiller shutdown".

(6) Control procedures for auxiliary equipments

Refer to "2-3 Control procedures for auxiliary equipments".

(7) Action after the power fail recovery

Refer to "2-4 Action in case of the power failure".

(8) Periodic check of safety devices

Safety devices need periodic check for safety use. We recommend performing these by our service engineer. The contents of periodic check are indicated in section 5.

(9) Monitoring of the operating condition

In case the chilled water outlet temperature is not lowered to the set value for a while, the heat input may not be sufficient or the chilled water may be overloaded. In order to prevent any damage or failure to the Chiller in such cases, make sure to check the operating conditions and the state of Chiller.

2-1. PRECAUTIONS WITHIN 1 HOUR AFTER THE CHILLER STOP

- (1) Never operate the cooling water pump within 1 hour after the chiller stop. Otherwise, there is a possibility of chilled water freezing in the evaporator tube. Please operate the cooling water pump automatically by a signal from the chiller.
- (2) If you operate the cooling water pump within 1 hour after the chiller stop, the chilled water pump will operate automatically to prevent chilled water freezing. Caution labels are put on the control pane of chiller and field supply panel.

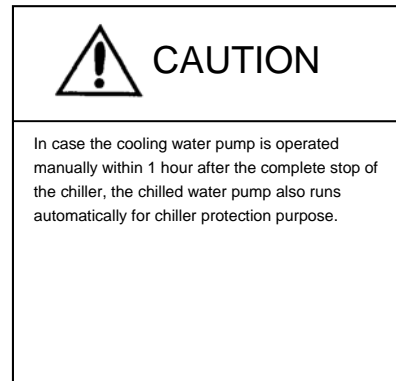
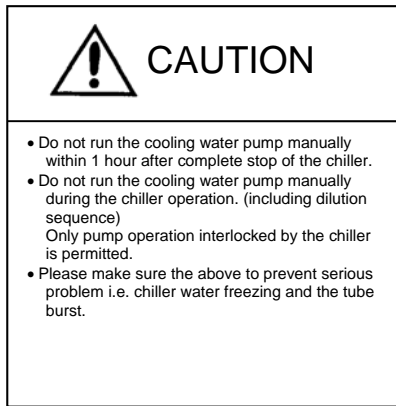

- (3) When the chiller is used for cooling and you want to operate the cooling water pump within 1 hour after the chiller shutdown for preventing cooling water freezing, be sure to operate the chilled water pump at the same time for preventing chilled water freezing.

2-2. PRECAUTIONS AFTER THE CHILLER SHUTDOWN

Don't cut the power supply during the chiller is stopping.

- The chiller is watching vacuum level all the time.
- The chiller has a battery to maintain operating time and date during power failure. If power failure continues for a long time, there is a possibility that the battery runs down.

2-3. CONTROL PROCEDURES FOR AUXILIARY EQUIPMENTS

- (1) On-off control of the auxiliary equipments such as chilled water pump, cooling water pump, cooling tower fan and hot water pump shall be linked to the absorption chiller operation for the safety of the absorption chiller.
- (2) It is necessary to operate the auxiliary equipments following the interlocking signal from the chiller. Those equipments and the chiller shall be wired according to the manufacture's specified wiring diagram. The chiller includes "chilled water pump on-off signal" and "cooling water pump on-off signal" and "hot water pump on-off signal" as standard equipment system.
- (3) The chiller also includes "cooling tower fan on-off signal" as standard.

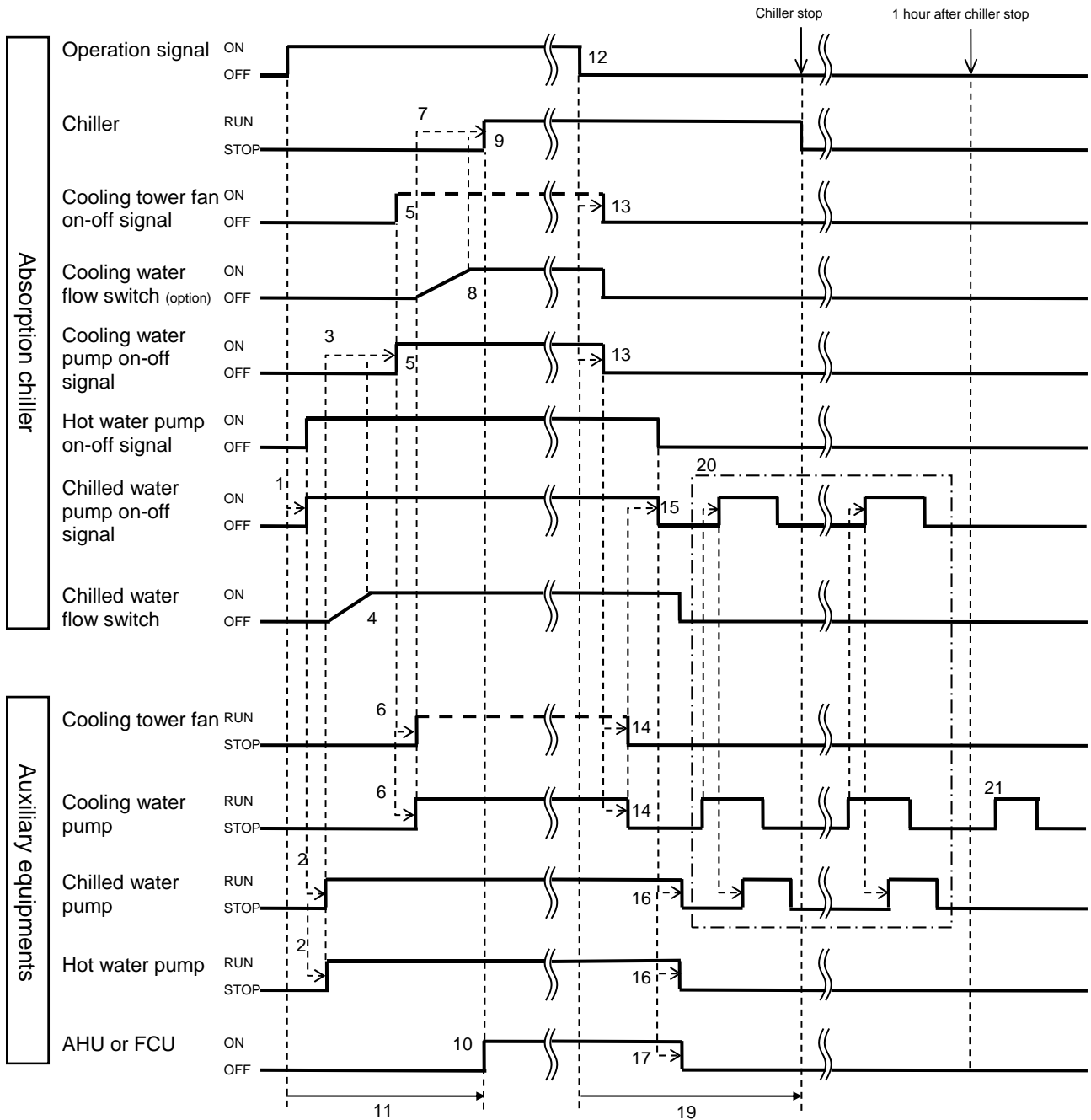

Detailed procedure

- (1) At the start of the chiller “chilled water pump on-off signal” and “hot water pump on-off signal” become ON.
- (2) Chilled water pump starts in conjunction with the above signal.
- (3) This makes the answerback signal return to the chiller.
- (4) The chiller control system confirms if the chilled water flow rate is enough.
- (5) By clearing the step 3 and 4, both the “cooling water pump on-off signal” and “cooling tower on-off signal” become ON.
- (6) Cooling water pump and cooling tower fan operate.
- (7) Interlock signal of the cooling water pump returns to the chiller.
- (8) The chiller control system confirms if the cooling water flow rate is enough.
- (9) By clearing the step 7 and 8, the chiller operates normally.
- (10) Operate the air handling units.
- (11) If the above process from 1 to 8 takes more than 10 minutes, interlock alarm comes ON and the chiller stops operation.
- (12) When the chiller receives a stop signal during operation, it starts dilution cycle.
- (13) In 1 to 5 minutes after starting the dilution cycle, “cooling water pump on-off signal” and “cooling tower on-off signal” become OFF.
- (14) Cooling water pump and cooling tower fan shall stop.
- (15) In one minute the signal of “chilled water pump on-off signal” become OFF but it keeps operating status with the alarm J-29 “cooling water pump operation malfunction” if cooling water pump does not stop.
- (16) Chilled water pump and Hot water pump shall stop.
- (17) Stop the air handling units after completing the step 16.
- (18) In 4 to 9 minutes after the step 16, the chiller completes the dilution cycle and stops operation entirely.
- (19) Period of the dilution cycle is 6 minutes at shortest and 15 minutes at longest in cooling mode.
- (20) If the ON signal of “cooling water pump on-off signal” comes to the chiller during the period between the stopping of chilled water pump and the entire shutdown of the chiller or within one hour after the entire shutdown of the chiller, “chilled water pump on-off signal” becomes ON and chilled water pump is forced to operate to prevent the chilled water freezing. In this case the alarm J-29 “cooling water pump operation malfunction” occurs simultaneously.
- (21) After one hour of the entire shutdown of the chiller, “chilled water pump on-off signal” or alarm signals shall not be output even if the ON signal of “cooling water pump interlock signal” comes to the chiller.

Note

- (1) Air handling units shall be stopped after confirming stopping of the chilled water circulation.
- (2) Cooling water circulation shall be completely stopped whenever the chilled water stops its circulation.
- (3) Confirmation of the cooling water flow rate is possible with an optional specification of a cooling water flow switch. (step 8)
- (4) The “cooling tower fan on-off signal” should be controlled with cooling water temperature therefore interlock between the fan and the chiller is not necessary.
- (5) Never operate the cooling water pump within one hour after the entire shutdown of the chiller. Otherwise, the chilled water pump is forced to operate to prevent the chilled water freezing.

2-4. ACTION IN CASE OF THE POWER FAILURE

(1) Flowchart

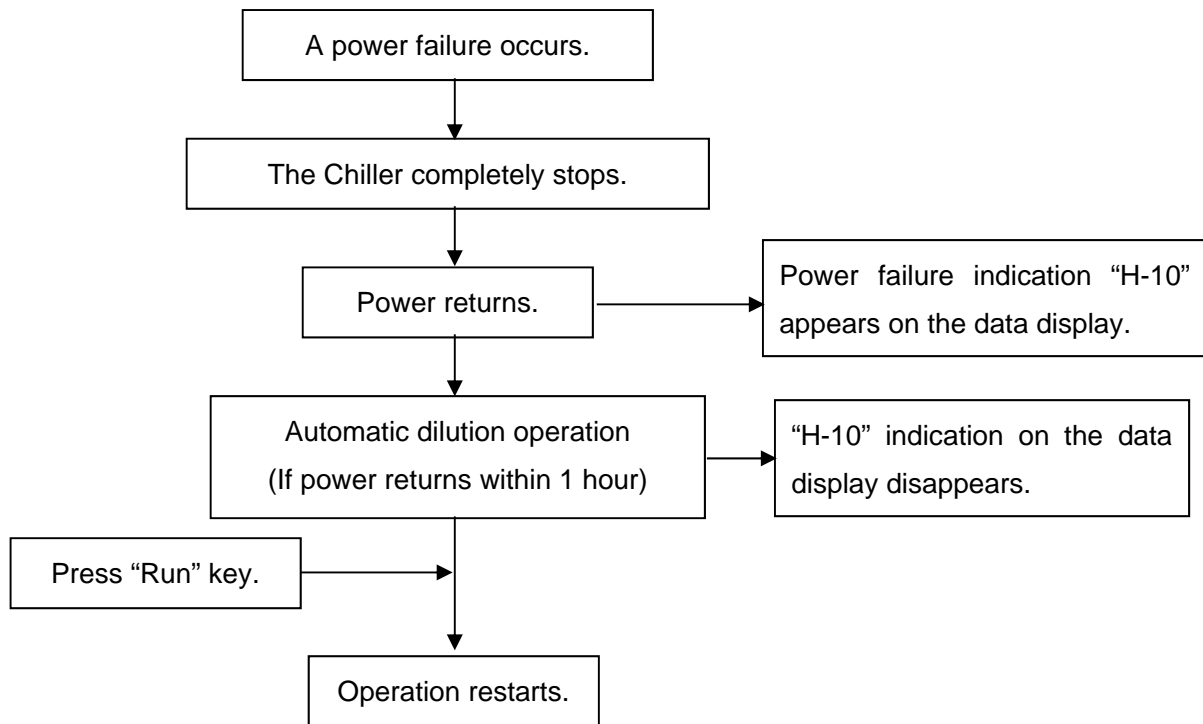

(2) Immediate action

When a power failure occurs, the Chiller stops completely without dilution cycle operation. Special attention should be paid to the following.

Operating condition at power failure	Action
During cooling operation and it took 1 hour or more to power return.	Immediately contact Carrier service agent. Do not restart operation. "A-05" appears on the display.
During cooling operation and it took less than an hour to power return.	The chiller starts dilution operation automatically if power returns within 1 hour. After that, restart operation.
During purging operation.	Immediately close the purge valve completely and turn off the purge pump switch on the control panel. After power returns, restart purging, and contact Carrier service agent.

2-5. NOISE DATA

Model : 16LJ-A	11	12	13	14	21	22	23	24	31	32	41	42
Noise [dB(A)]	81.5	81.5	81.5	81.5	78.0	78.0	81.7	81.7	78.0	78.0	79.0	79.0

Model : 16LJ-A	51	52	53	61	62	63	71	72	73	81	82
Noise [dB(A)]	81.0	81.0	81.0	81.0	81.0	81.0	81.0	81.0	81.0	81.0	81.0

The noise level may vary depending on ambient conditions and specifications.

These value established on the actual measurements or the basis of measurements taken for similar models.

3. ILLUSTRATION

3-1. DETAIL OF TYPICAL CHILLER

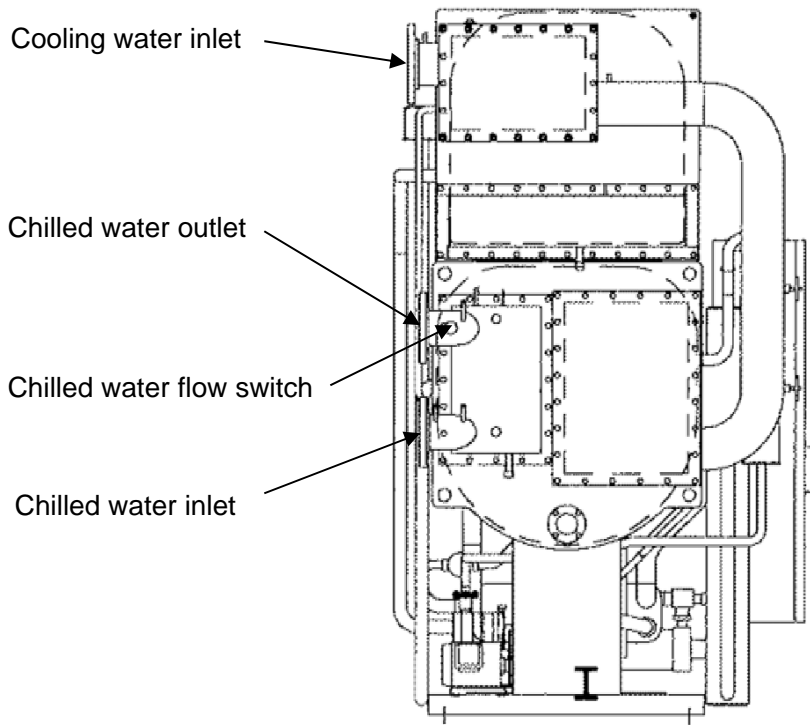

WATER HEADER SIDE

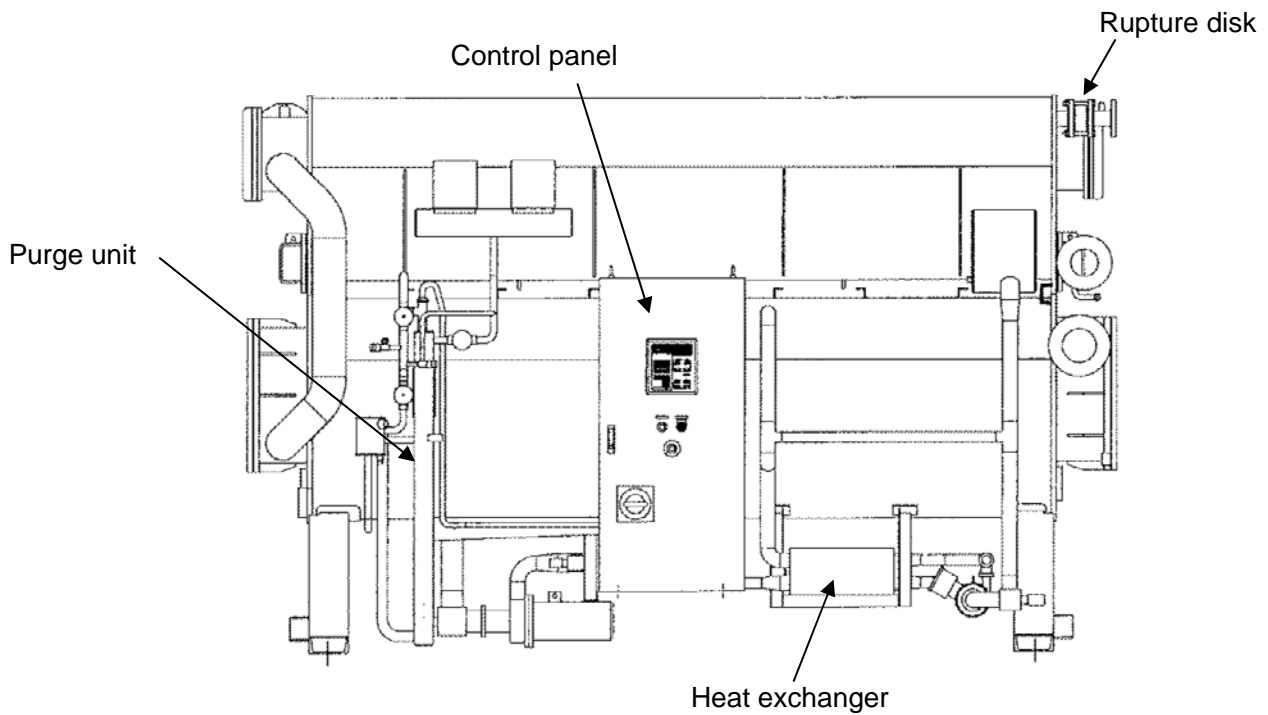

CONTROL PANEL SIDE

Note: The positions or quantity of parts differ according to the model and options.

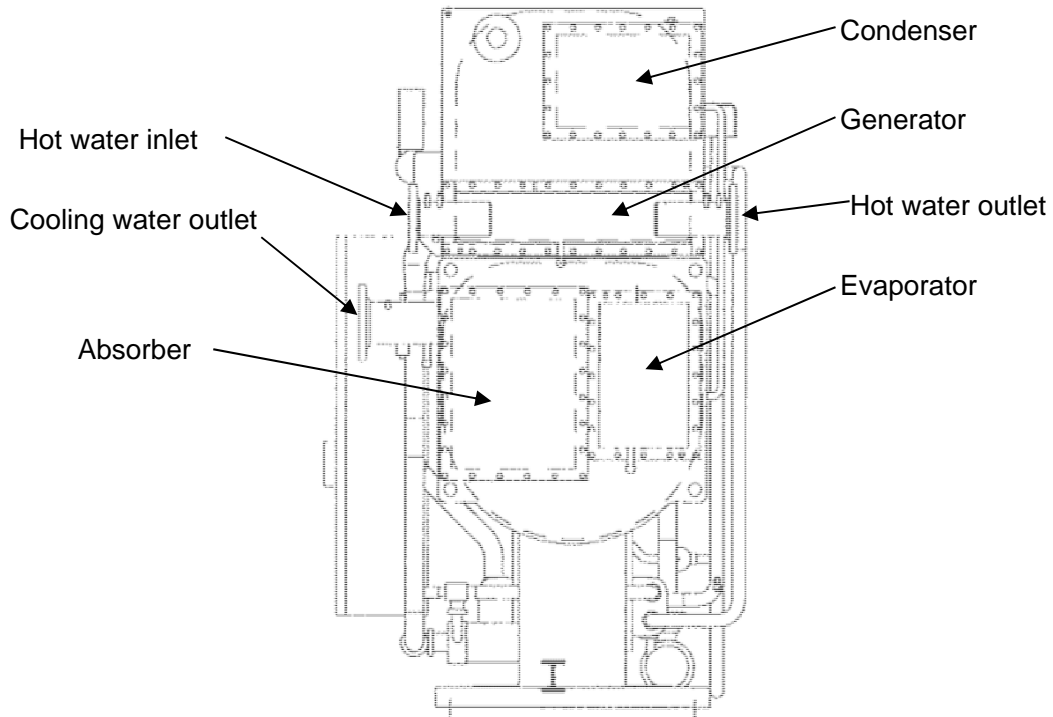

WATER HEADER SIDE (OPPOSITE)

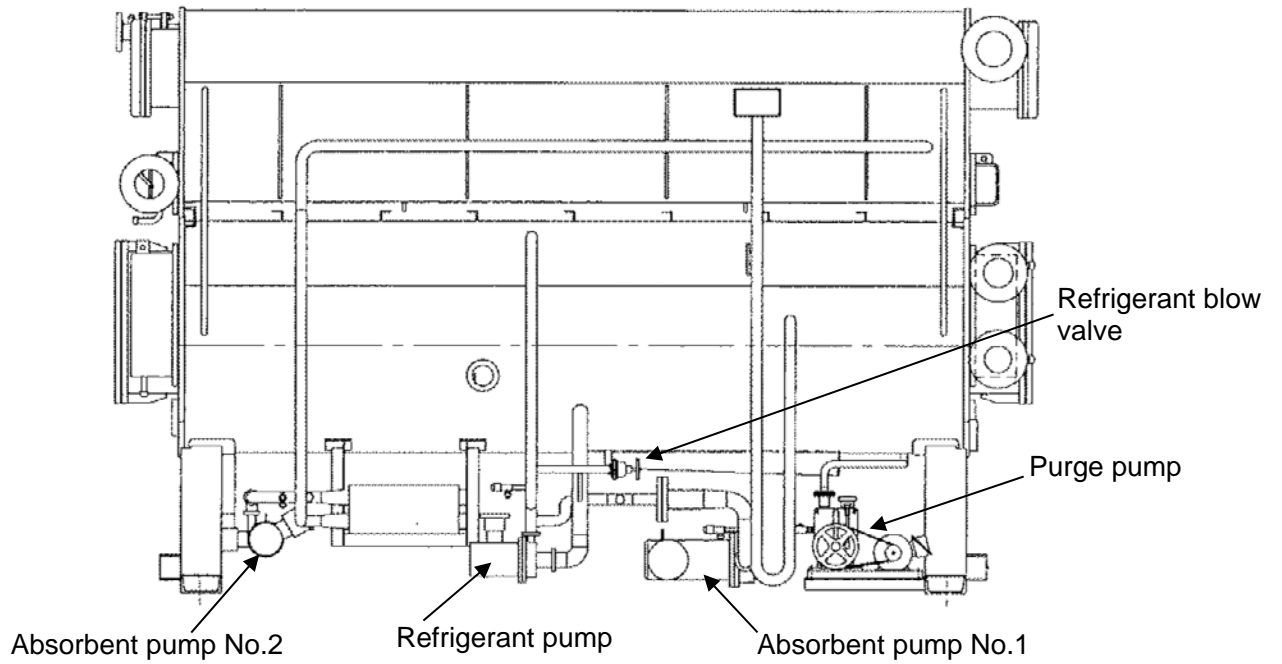

EVAPORATOR SIDE

Note: The positions or quantity of parts differ according to the model and options.

3-2. TYPICAL CONTROL PANEL

3-2-1 UL type

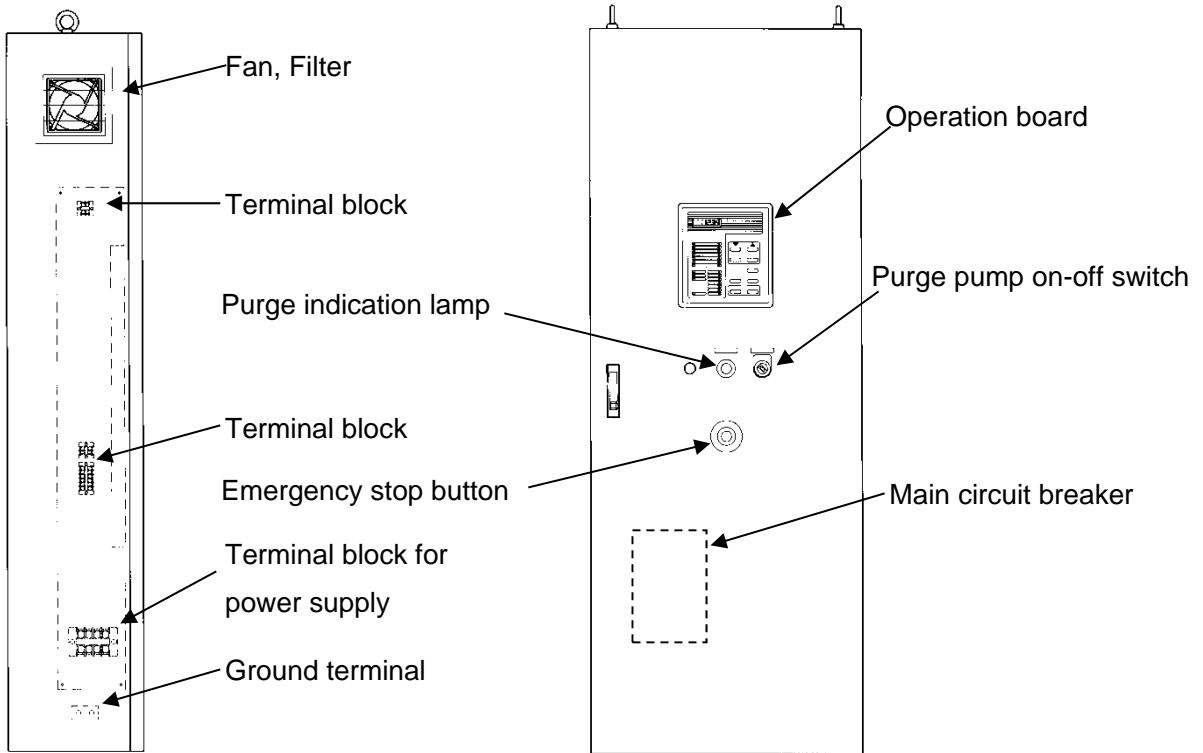

!! CAUTION !!
 Do not push the emergency stop button except in emergency.
 Otherwise the chiller/heater may be damaged.

3-2-2 CE type

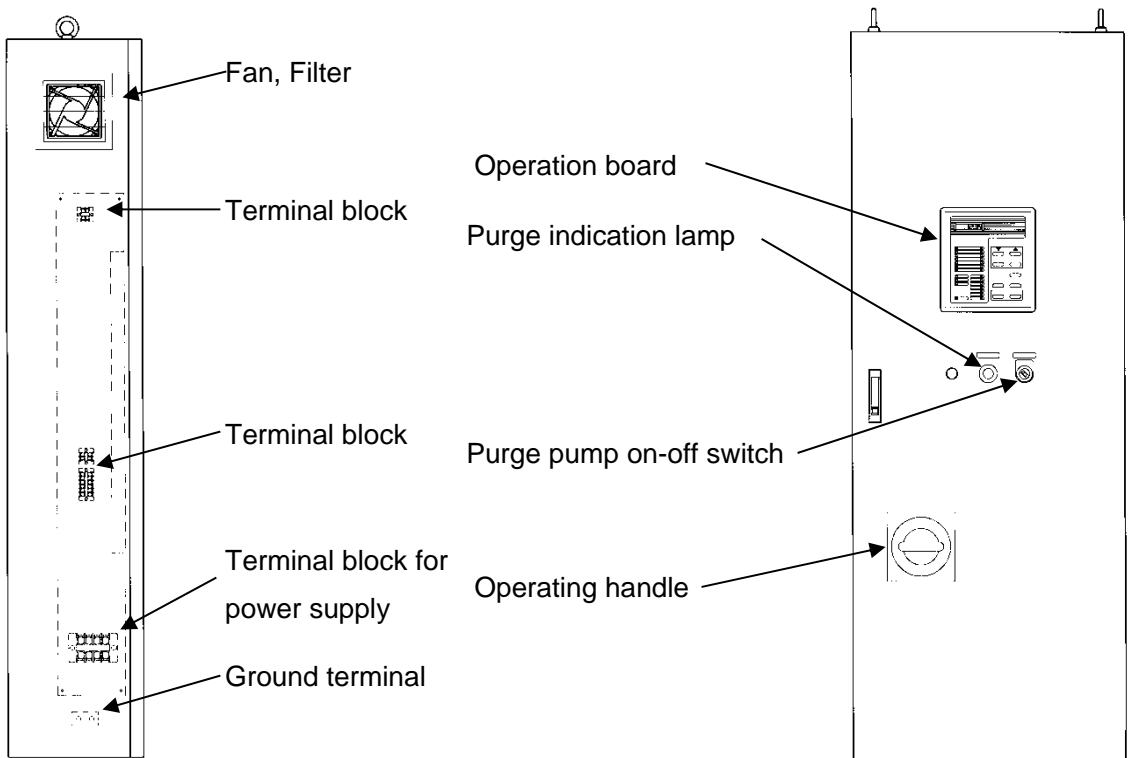

Note: The positions or quantity of parts differ according to the model and options.

3-3. FLOWCHART OF CHILLER AND FUNCTION OF EACH SECTION

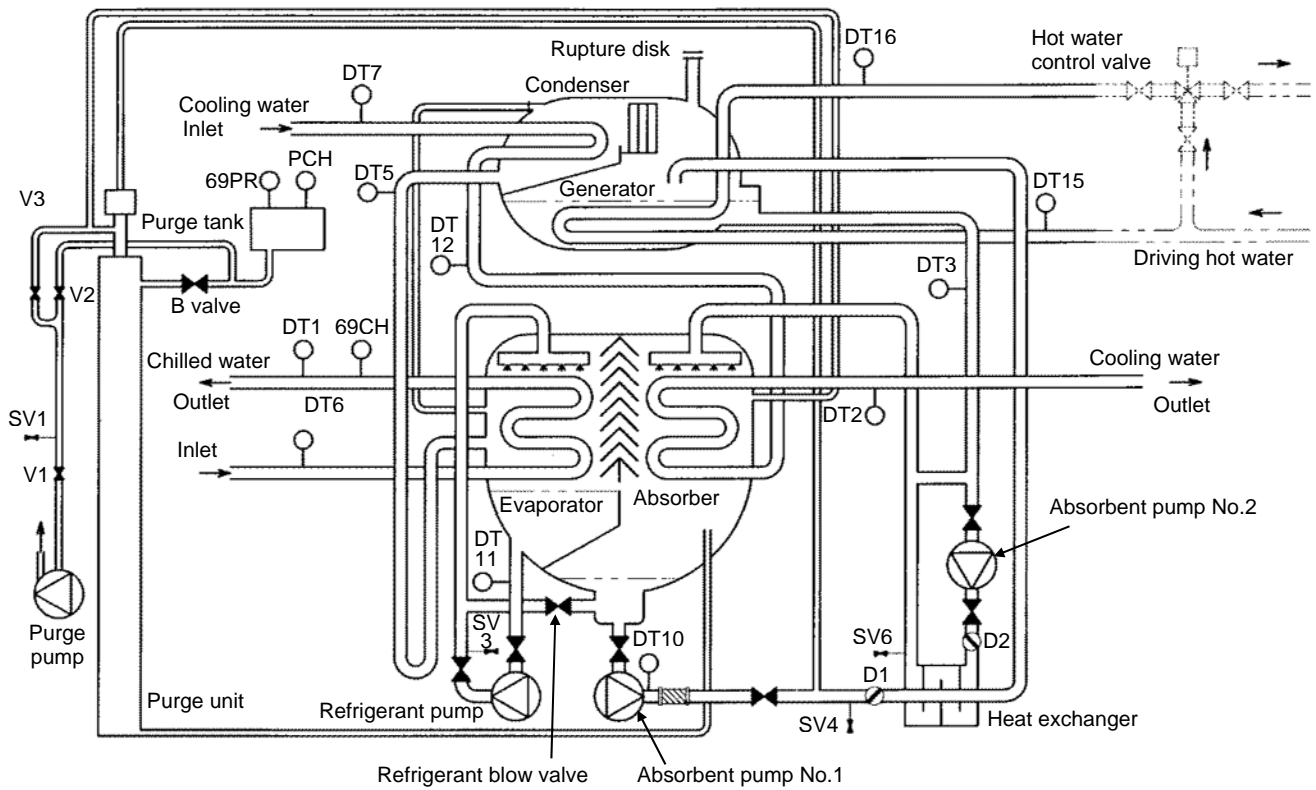

FLOW DIAGRAM

a) **EVAPORATOR**

Refrigerant is dispersed on the heat transfer tubes of evaporator. Chilled water through the tubes is cooled by the latent heat of vaporized refrigerant.

b) **ABSORBER**

Concentrated solution is dispersed on the heat transfer tubes of absorber. The refrigerant vapor from evaporator is absorbed on the tubes by the concentrated solution. Cooling water through the tubes is heated by absorption heat.

c) **HEAT EXCHANGER**

Diluted solution, after leaving the absorber section, passes through the heat exchanger where it is heated by the concentrated solution. The concentrated solutions are cooled by the diluted solution. This cooling process of the concentrated solution allows for greater absorbing power due to its lower temperature.

d) **GENERATOR**

The diluted solution from the heat exchangers is heated in the generator. It releases refrigerant vapor and concentrated solution by the condensation.

e) **CONDENSER**

The refrigerant vapor from the generator is condensed on the heat transfer tubes of condenser. Cooling water from the absorber is heated by condensation heat.

f) **PURGE UNIT**

Gather the non-condensable gas within the Chiller and store it in the purge tank.

The List of sensors

SYMBOL	NAME
DT1	Chilled water outlet temperature
DT2	Cooling water outlet temperature
DT3	Generator temperature
DT5	Condenser temperature
DT6	Chilled water inlet temperature
DT7	Cooling water inlet temperature
DT10	Diluted solution temperature at Absorber outlet
DT11	Refrigerant temperature at Evaporator
DT12	Cooling water mid temperature
DT15	Driving hot water inlet temperature
DT16	Driving hot water outlet temperature
69CH	Chilled water flow switch
PCH	Palladium cell heater
69PR	Purge tank pressure

The quantity of sensors differs according to the model and options.

4. OPERATING INSTRUCTIONS

4-1. TURN ON THE MAIN CIRCUIT BREAKER

Self-diagnostic function starts when the breaker inside the control panel of the Chiller is turned on.

After completing the self-diagnosis, the data display on the operation board shows the following.

- (1) Data display (7 segment LED) and all LEDs light up.
- (2) The data display shows a version number of the microprocessor when there is no abnormality. If there was a power failure, H-10 is displayed with the restriction of power.



UEr 1.00

NOTE : The version number differs according to the chiller

- (3) The data display shows the generator temperature.



120.4

(120.4)

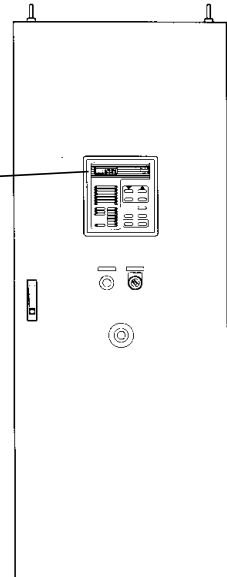

If the self-diagnostic function detects any failure, it will be shown the alarm code on the data display. In this case, please contact the service agent accordingly.

4-2. DESCRIPTION OF KEYS AND THEIR FUNCTIONS

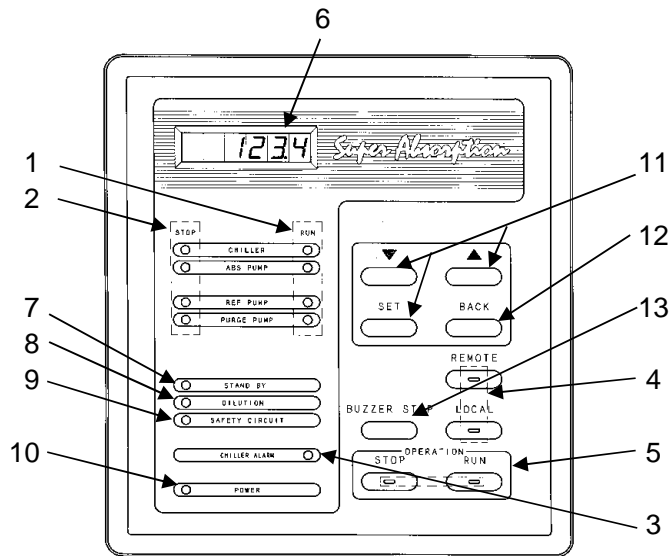

- | | |
|-----------------------------------|--------------------------------------------------------------------------------------------------------------|
| 1. Operation indication lamp | :Operation indication lamps light while the chiller, pumps, etc. operate. |
| 2. Stop indication lamp | :Stop indication lamps light while the chiller, pumps, etc. stop. |
| 3. Alarm indication lamp | :Alarm indication lamps light up when an abnormality occurred. |
| 4. Remote/local select key | :It is used to select remote operation or local operation. |
| 5. Run/Stop select key | :It is used to operate or stop the chiller.
The stop key is also used to reset the alarm. |
| 6. Data display(7 segment LED) | :It shows temperature, set value, etc.. |
| 7. Stand by indication lamp | :It lights up by pressing the run key and goes out when the chiller starts operation. |
| 8. Dilution indication lamp | :It lights during a dilution operation. |
| 9. Safety circuit indication lamp | :It lights up when the control circuit is energized. |
| 10. Power indication lamp | :It light up when the power is supplied to the control panel and the main breaker in the panel is turned on. |
| 11. Data select key | :These are used to select the display data and to change set value. |
| 12. Back select key | :It is used to return back the display data to the generator temperature. |
| 13. Alarm buzzer stop key | :It is used to stop the alarm buzzer. |

4-3. OPERATION

4-3-1. Pre-operation check

Check the following items before starting operation.

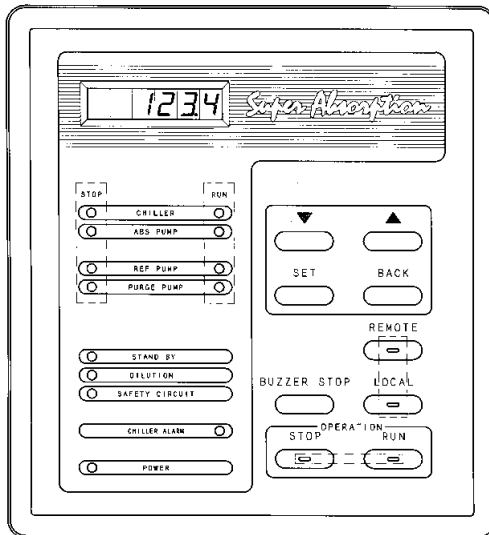

- (1) Check of the setting point of the chilled water outlet temperature
Make sure that the chilled water outlet temperature is set as specified.
As for the indication of set value, please refer to Section 4-5.
- (2) Check of the hot water line
 - a) Make a daily inspection.(Refer to Section 5.)
 - b) Check that the valve(s) is open.

NOTE : The chilled water pump and the cooling water pump should be operated by on-off signal from the chiller.
If the chiller starts, these equipments also will start automatically.

4-3-2. Start a operation

(1) Local operation mode

- a) Confirm the "LOCAL" indication lamp of the key lights.
- b) Keep pressing "RUN" key for more than a second and make sure that "RUN" indicator lamp of the key lights.
- c) Automatic operation starts.

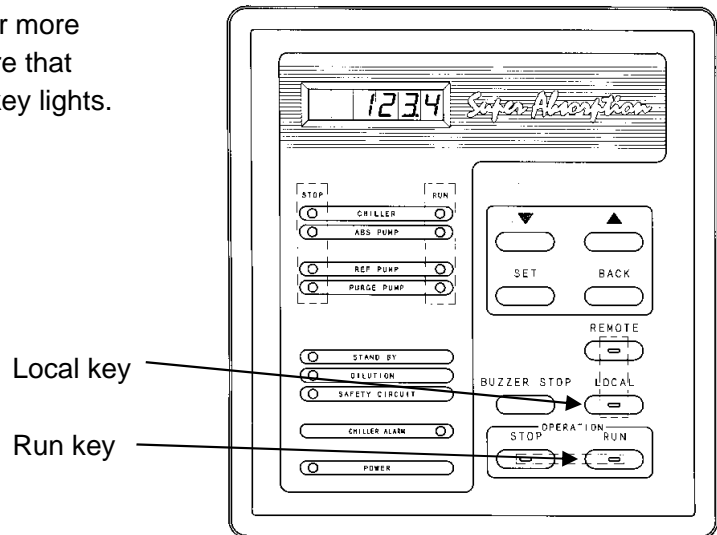

(2) Remote operation mode

- a) Confirm the "REMOTE" indication lamp of the key lights.
- b) Turn on the start switch on the remote control panel of field supply.
- c) Automatic operation starts.

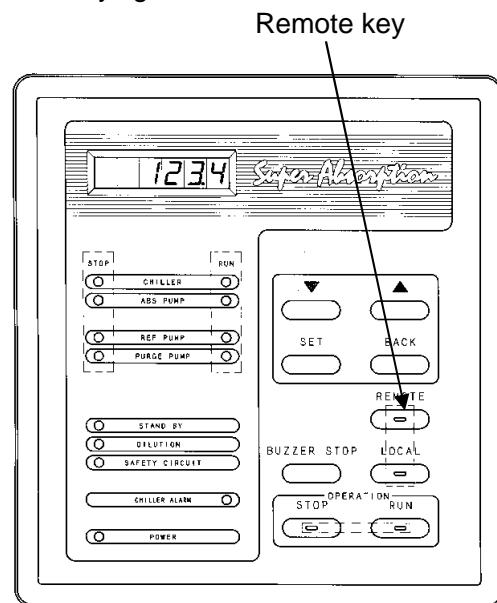

NOTE : In the local operation mode, a signal from the remote control panel is not effective. In the remote operation mode, "RUN" key on the operation board of the Chiller does not work.

4-3-3. Stop a operation

(1) Local operation mode

- a) Keep pressing "STOP" key on the operation board for more than a second.
- b) Make sure that "RUN" indication lamp goes off and "STOP" indication lamp lights.

Stop key

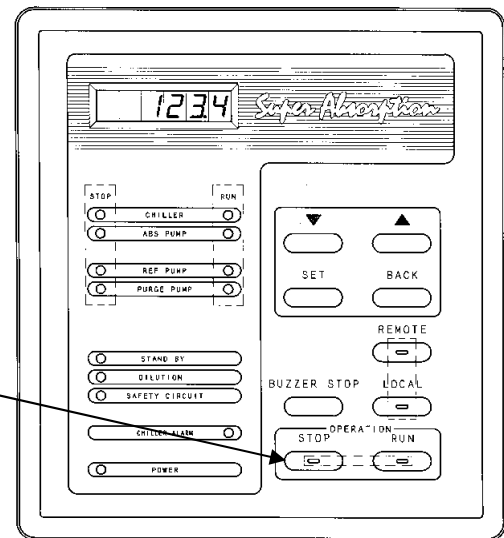

(2) Remote operation mode

- a) Turn on the stop switch on the remote control panel of field supply.
- b) Another way to stop the Chiller is to press "STOP" key on the operation board during a remote operation.

NOTE : The chilled water pump and the cooling water pump should be operated by on-off signal from the chiller. If the chiller starts, these equipments also will start automatically. Air handling unit must be stopped **after the chilled water pump is stopped.**

4-4. HOW TO CHANGE THE INDICATION ON DATA DISPLAY

4-4-1. Regular indication

Data display on the operation board usually shows generator temperature as follows.

(Display Example)

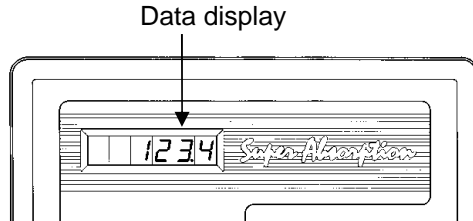

It returns to the generator temperature indication when there is no key operation for 1 minute.

4-4-2. How to change the indication

If you press ▲ key, the indication on data display changes in ascending order, and by pressing ▼ key, it changes in descending order.

If you press ▲ key again when you get to the last indication, it returns to the regular indication.

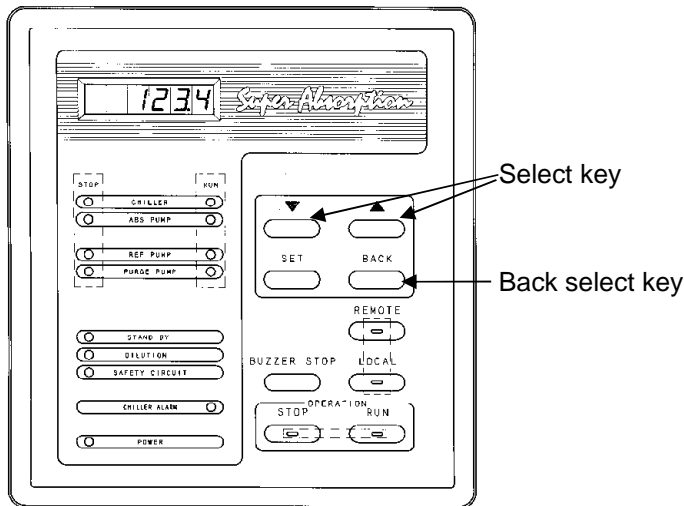

4-4-3. Typical indication flow

Data can be displayed in real time. Operation time, on-off times, temperature, set value, alarm informations etc are displayed. Each data is identified by the data code.

You can scroll the data code by ▲▼ key. It shows an alarm code only when an abnormality occur and when multiple abnormality occurs the highest-priority one is displayed and a dot is shown at the bottom right of the alarm code.

The remaining alarm code can be shown with ▲▼ key.

When there is no key operation for 1 minute or "Back" key is pressed, the display returns to generator temperature indication.

Typical indication flow

Data code	Data name	Display	Meaning
-	Generator temperature	135.0	135.0 °C (°F)
1.	Chiller operation hours	1 1234	1234hours
2.	#1 absorbent pump operation hours	2 1111	1111hours
3.	#2 absorbent pump operation hours	3 1230	1230hours
4.	-	4 - - - -	not used
5.	-	5 - - - -	not used
6.	Refrigerant pump operation hours	6 1201	1201hours
7.	Purge pump operation hours	7 107	107hours
8.	-	8 - - - -	not used
9.	Combustion hours	9 0	not used
A.	Chiller on/off times	A 123	123times
B.	#1 absorbent pump on/off times	B 169	169times
C.	#2 absorbent pump on/off times	C 123	123times
D.	-	d - - - -	not used
E.	-	E - - - -	not used
F.	Refrigerant pump on/off times	F 138	138times
G.	Purge pump on/off times	G 51	51times
H.	-	H - - - -	not used
I.	Combustion on/off times	I 0	not used
10.	Chilled water temperature setting point *1	10 7.0	7.0 °C (°F)
11.	Hot water temperature setting point	11 0	not used
12.	Chilled water inlet temperature	12 11.9	11.9 °C (°F)
13.	Chilled water outlet temperature	13 6.8	6.8 °C (°F)
14.	-	14 - - - -	not used
15.	-	15 - - - -	not used
16.	Cooling water inlet temperature	16 31.8	31.8 °C (°F)
17.	Driving hot water inlet temperature *2	17 90.0	90.0 °C (°F)
18.	Hot water control valve return temperature	18 - - - -	option
19.	Condenser temperature	19 34.7	34.7 °C (°F)
20.	Driving hot water outlet / steam drain / exhaust gas temperature	20 80.0	80.0 °C (°F)
21.	Purge tank pressure	21 8.5	8.5kPa
-	Generator temperature	135.0	135.0 °C (°F)

*1 It will display flick at the time of remote setting

*2 It may not display depending on the specification

4-5. HOW TO CHANGE THE INDICATION AND THE SETTING POINT

4-5-1. Indication of setting

The present "chilled water temperature setting", or "Hot water temperature setting" can be checked by following Section 4-4-2. How to change the indication.

4-5-2. How to change setting

After showing present setting, it can be changed in the following process.

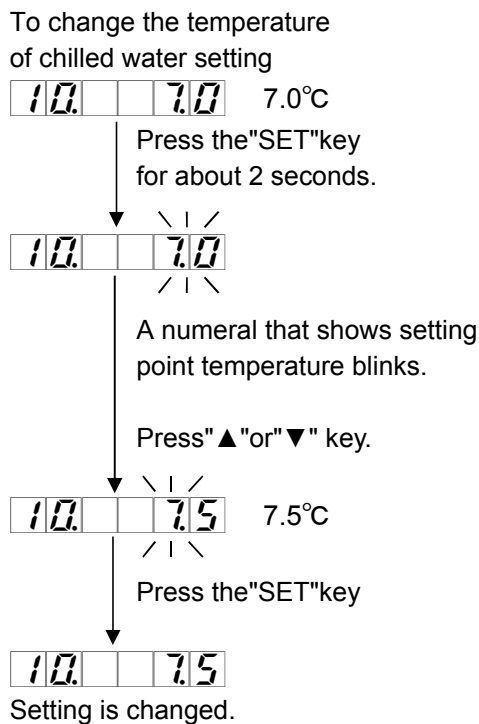

When there is no key operation for 1 minute or "BACK" key is pressed, the display returns to generator temperature indication.

NOTE 1: Wrong setting may cause a failure of the Chiller.
If you need to change setting, be sure to contact service agent

NOTE 2: The changed setting become instantly effective upon changing it.
Be careful in changing the set values during operation.

4-6. MAINTENANCE MESSAGE

4-6-1. Function

When a trouble which could disturb an efficient operation of the Chiller is predicted, it shows a notice.

4-6-2. How it is shown

Data code is indicated on the data display as follows.

Maintenance message

	Data code	Data name
★	H-01	Operate purge pump
★	H-03	Clean cooling water tubes
★	H-04	Check cooling water system
☆	H-06	Purge tank high pressure
☆	H-07	Cooling water tubes foul
☆	H-08	Cooling water high tem.
	H-10	Power failure

★ mark : The Chiller needs an immediate action.

☆ mark : The Chiller does not need an immediate action.

However, as this might lead to ★ mark code, attention should be paid.
Consult a service agent at the next periodic maintenance.

NOTE : These indications disappear when the failure is corrected.

4-6-3. Descriptions of maintenance message and actions to be taken

Descriptions and actions by category

	Maintenance Message	Display	Action
1	Fouling of cooling water tubes	H - 07 H - 03	Cooling water tubes must be cleaned. Contact a service agent to do the job.
2	Vacuum rate	H - 06 H - 01	Purge indication lamp lights at the same time The purge tank must be purged immediately. In case this indication is shown frequently, contact a service agent.
3	High temperature of cooling water	H - 08 H - 04	Check the cooling water pump, cooling tower, etc.
4	Power failure	H - 10	See section 2-4.

4-7. ALARM INDICATIONS AND ACTIONS TO BE TAKEN

4-7-1. How they are shown

When an abnormality is detected, alarm buzzer sounds(option) and the alarm code is shown on the data display and the indication lamp of "STOP" key blinks.

The Chiller stops for safety reasons after a dilution cycle operation.

Depending on the kind of the alarm, it stops without a dilution cycle operation.

Display example :  Chilled water low temperature

When plural abnormality occurs, a higher priority code is shown and a dot is marked at the bottom right of the alarm code as shown below.

Display example :  Chilled water low temperature

In this case the next priority code can be shown by pressing ▲ key.

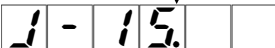
Display example :  High temperature generator's solution level is too low.

4-7-2. Actions to be taken

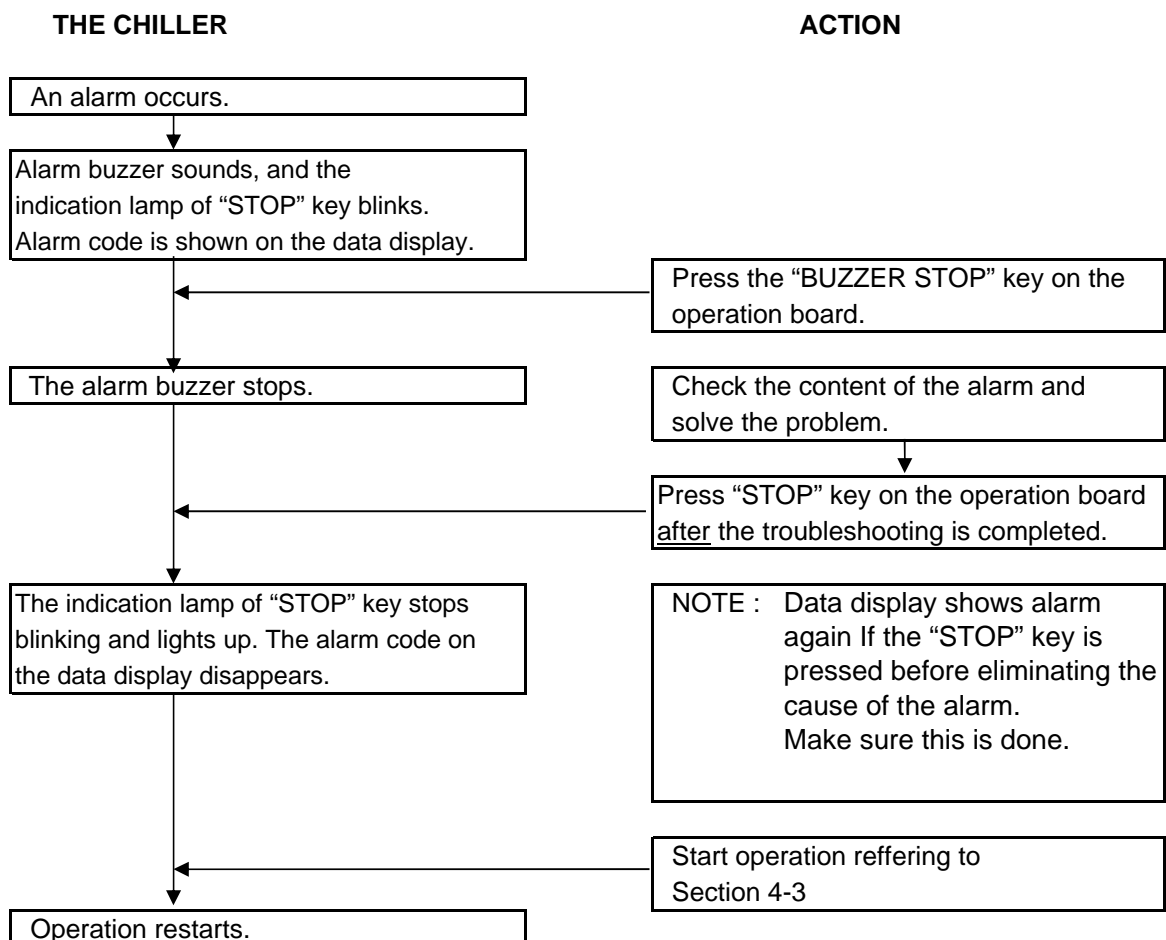

4-7-3. Content of alarm and setting

List of alarm and setting

Purpose	Display	Contents of alarm	Set point
Chilled water freeze protection	J - 01	Chilled water temperature is too low.	2.5°C(36.5°F) or below
	J - 02	Chilled water pump interlock failure	-
	J - 03	Few flow rate of chilled water	50% or below
	J - 20	Cooling water temperature is too low.	24°C(75.2°F) or below continues 30 minutes
	J - 29	Cooling water pump operation failure.	-
	J - 31	Refrigerant temperature is too low.	2.0°C(35.6°F) or below
Crystallization prevention	J - 06	Cooling water pump interlock failure	-
	J - 07	Few flow rate of cooling water(option)	50% or below
	J - 13	Generator's temperature is too high.	105°C(221°F) or above
Protection of generator	J - 16	High concentration of absorbent	2 times of 65.0% or above 65.5% or above
Motor protection	J - 04	No.1 Absorbent pump is overloaded.	Rated current value or above
	J - 05	No.2 Absorbent pump is overloaded.	
	J - 10	Refrigerant pump is overloaded.	
	J - 12	Purge pump is overloaded.	
Others	J - 11	Chilled water flow switch failure	-
	J - 21	Cooling cycle failure	*1
	B - 05	Power failure (while operating)	More than 1 hour

*1 Chilled water temp. difference 1.0°C(1.8°F) or below for 30min. at 85% or above input.

4-7-4. Locating Alarm and Disposal

List of Alarm Indications with their Causes and Remedies in cooling mode

Display	alarm	Set point	Recovery point	Action
J-01	Chilled water low temp.	2.5°C or below (36.5°F)	above 2.5°C (36.5°F)	Contact a service agent. Check other alarm with ▲key
J-02	Chilled water pump	interlock OFF	interlock ON	Operate the chilled water pump after checking the cause of alarm. If you can not find a cause, contact a service agent.
J-03	Chilled water flow	50% or below	above 50%	
J-20	Cooling water low temp.	24°C or below (75.2°F) for 30 minutes	above 24°C (75.2°F)	Operate the chiller after checking the setting of cooling water temp. If the alarm occurs again, contact a service agent.
J-29	Cooling water pump failure	Cooling water pump ON within 1 hour after the chiller shutdown	Cooling water pump OFF	Stop the cooling water pump.
J-31	Refrigerant low temp.	2.0°C or below (35.6°F)	above 2.0°C (35.6°F)	Contact a service agent. Check other alarm with ▲key
J-06	Cooling water pump	interlock OFF	interlock ON	Operate the cooling water pump after cheking it.
J-07	Cooling water flow	50% or below	above 50%	Operate the cooling water pump after cheking the cause of alarm. If you can not find the cause, contact a service agent.
J-13	Generator high temp.	105°C(221°F) or above	below 105°C (221°F)	Contact a service agent. Check other alarms with ▲key
J-16	High concentration	2 times of 65% or above. 65.5% or above	below 65%	
J-04	No.1 Absorbent pump	Rated current value or above	Reset the thermal relay	Contact a service agent. Check other alarms with ▲key If the alarm occurred during purging, shut the diaphragm valves immediately.
J-05	No.2 Absorbent pump			
J-10	Refrigerant pump			
J-12	Purge pump			
J-11	Chilled water flow switch	Flow switch ON during the chiller stops	Flow switch OFF during the chiller stops	Contact a service agent. Check other alarms with ▲key
J-21	Cooling cycle failure	Chilled water temp. difference 1.0°C(1.8°F) or below for 30min. at 85% or above input.	above 1.0°C(1.8°F) at 85% or above input.	Contact a service agent. Check other alarms with ▲key
A-05	Power failure (while operating)	More than 1 hour	Alarm reset	See chapter 2, 2-4

5. MAINTENANCE

5-1. DAILY INSPECTION

If you find an abnormal condition, contact a service agent.

- (1) Abnormal noise of absorbent pump and refrigerant pump.

Consult the plant management company for the following items.

- (2) Cleaning of the cooling tower and the strainer of the cooling water line.
- (3) Check of the cooling tower condition.
- (4) Check of the air binding in the pipe line.

5-2. PERIODIC MAINTENANCE

To use the chiller in optimum performance, it requires periodic service such as purging, refrigerant blow down and absorbent control, etc. We recommend you to make a maintenance contract with the service agent.

5-2-1. Purging

The air of the machine inside not only decreases cooling capacity but also has a bad influence on the life of the machine. Please leave it to service personnel under the maintenance contract. The customer can carry out the purging, but should follow the instructions of our service personnel.

Purging procedure

The opening / closing condition of each valve:

V1: Close, V2: Close, V3: Close, B valve: Open

- a) Turn on the purge pump on/off switch on the control pane.
- b) Close B valve
- c) Open V1 and V2.
- d) Press "▲" key on the operation board once to indicate 17. Check the purge tank pressure (refer to section 4-6-3) and confirm whether the indicated value drops below 0.5kPa. If it does not drop, close V1 and V2, and contact the service agent.
- e) Open B valve
- f) Perform purging for 10 minutes. Even if the purge indication lamp goes out within 10 minutes, continue purging for 10 minutes. When the lamp does not go out, continue purging until the lamp goes out.
- g) Close V2 and open V3
- h) After 30 minutes from g), close V3
- i) After 30 minutes from h), close V1.
- j) Turn off the purge pump on/off switch.
- k) Check again the opening / closing condition of each valve.

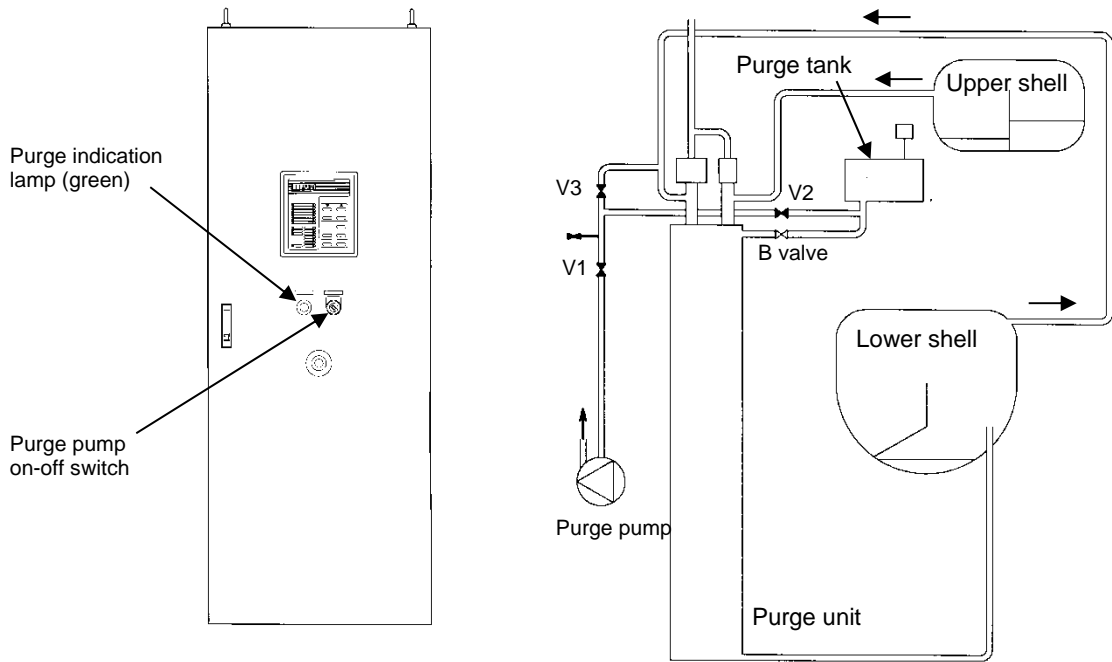

- 1) Open the gas ballast valve slightly until you can hear the exhaust sound. If you open it fully, purge pump oil will become dirty easily.

5-2-2. maintenance of purge pump

If the purge tank pressure does not reach available vacuum level, replace the purge pump oil.

Procedure of replacing the purge pump oil

- a) Open the drain cock, and release all oil of the pump.
- b) Close the drain cock, and remove the cap.
- c) Fill fresh oil through the oil filling port. Refueling, the oil level should be kept above the oil level window of the red dot 5 ~ 6mm.

Stop the purge pump when you replace the oil.

The type of rotary pump oil differs depending on vapor pressure, viscosity, etc. The use of a wrong type of oil can lower the pump performance. So use the attached pump oil.

If the ultimate pressure cannot be attained by oil change, sludge or other deposit may have collected on the bottom of the pump case. In that event, overhaul is required. Contact our service agent.

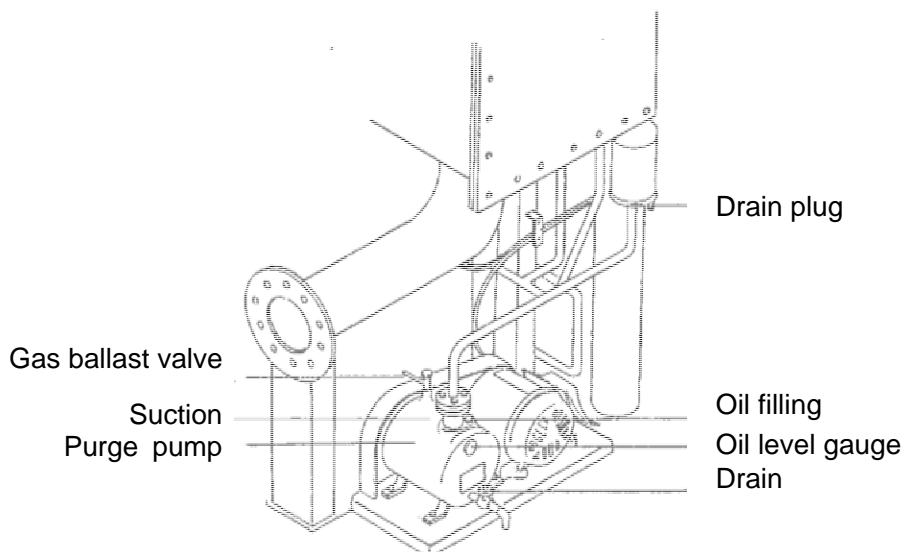

5-2-3. Refrigerant blow down

During a cooling operation, a little quantity of absorbent could mix into the refrigerant. Accumulated amount of the mixed absorbent could increase by a long-term operation and result in lowering of the cooling capacity, therefore refrigerant blow down must be performed at least once in a cooling season. By this work, the contaminated refrigerant is transferred to absorber side, and new, clear refrigerant is replaced.

- (1) Make sure the refrigerant pump is operating, and also the refrigerant level is visible through the sight glass of the evaporator.
- (2) Open the blow valve completely.
- (3) When the solution level becomes invisible, close the blow valve tightly.

The above is the blow down procedure.

Repeat it a few times as necessary.

As for the refrigerant blow down, please make a maintenance contract with the service agent.

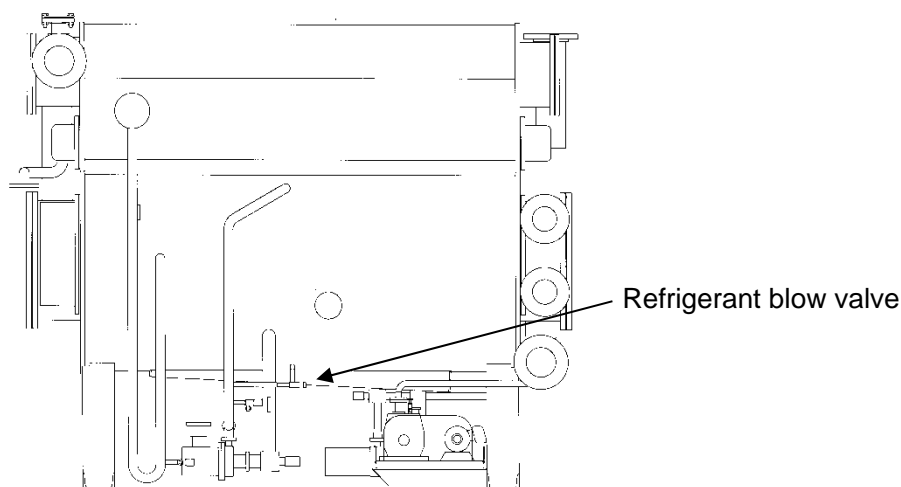

5-2-4. Management of the Absorbent solution

- (1) Inspection and quality control of the absorbent solution

Lithium bromide (LiBr) solution is used as absorbent in the absorption chiller system. As it has similar in nature to salt, the solution is corrosive therefore anticorrosive is added.

Concentration of the anticorrosive shall be checked periodically because it will be consumed with operating hours, and therefore the concentration shall be controlled to keep the optimum level.

This follow-up management is seriously important to prevent a metal corrosion inside the unit and thereby to ensure the long-life operation.

As for the management of the absorbent solution, make a maintenance contract with the service agent.

- (2) Regeneration of the absorbent solution

Even if absorbent is managed periodically, contamination and impurity will increase after a long time operating.

In this case, consult to our service agent.

5-3. WATER TREATMENT

5-3-1. Water treatment for Chilled water and Cooling water

1. Importance of water treatment

Absorption chiller use copper tubes to prevent corrosion due to the use of fresh water (tube material : JIS H 3300 C1201TS). However there is a possibility of corrosion due to water pollution or poor water quality.

2. Analysis of water quality

Check the water quality of make up water to satisfy the water quality guideline "JRA GL-02-1994".
About the analysis of water quality, contact a water treatment company.

3. Method of water treatment

(1) Blow down

Manage the recycling water quality to satisfy the water quality guideline "JRA GL-02-1994".

(2) Addition of anticorrosive

Contact a water treatment company.

4. Precaution

In case of using a black pipe for cooling water line or chilled water line, use an anticorrosive for black pipe to prevent adherence of the iron rust on copper tubes of the chiller.

- (1) Adherence of fouling like the iron rust on copper tube may cause a corrosion. It is necessary to add an anticorrosive for copper tube. Consult a water treatment company.
- (2) Do not install the cooling tower near an exhaust gas outlet or ventilation port. Otherwise, the quality of cooling water becomes poor and it causes corrosion problems.
- (3) In case of installing a heat storage tank in chilled water line, there is a possibility to cause a corrosion on the tubes by oxygen in chilled water or fouling of the heat storage tank. Install a heat exchanger between the heat storage tank and the chiller or consult a service agent.
- (4) When flashing of piping is performed at the first time, bypass the chiller to prevent foreign matter from getting into it.
- (5) In case of installing the chiller into an existing facility, there is a possibility to prevent a forming the anti corrosion film on copper tubes by influence of a fouling of the existing piping. Consult the service agent about the water treatment of post replacement.

5. Water quality standard

Water quality standard is shown below as an extract from JRA-GL02-1994.

Water quality standard for cooling water

		Cooling water line			Tendency		
		Circulation		One way	Corrosion	Scale	
		Circulation	Make up				
Standard	pH(at 25C(77F))		6.5 - 8.2	6.0 - 8.0	6.8 - 8.0	Yes	Yes
	Electrical conductivity 25C	ms/m	80 or less	30 or less	40 or less	Yes	Yes
	Chloride ion	mgCl/l	200 or less	50 or less	50 or less	Yes	
	Sulfuric acid ion	mgSO ₄ ²⁻ /l	200 or less	50 or less	50 or less	Yes	
	Acid consumption (pH 4.8)	mgCaCO ₃ /l	100 or less	50 or less	50 or less		Yes
	Total hardness	mgCaCO ₃ /l	200 or less	70 or less	70 or less		Yes
	Calcium hardness	mgCaCO ₃ /l	150 or less	50 or less	50 or less		Yes
	Ion silica	mgSiO ₂ /l	50 or less	30 or less	30 or less		Yes
Reference	Iron	mgFe/l	1.0 or less	0.3 or less	1.0 or less	Yes	Yes
	Copper	mgCu/l	0.3 or less	0.1 or less	1.0 or less	Yes	
	Sulfide ion	mgS ²⁻ /l	No detected	No detected	No detected	Yes	
	Ammonium ion	mgNH ₄ ⁺ /l	1.0 or less	0.1 or less	1.0 or less	Yes	
	Residual chlorine	mgCl/l	0.3 or less	0.3 or less	0.3 or less	Yes	
	Free carbon dioxide	mgCO ₂ /l	4.0 or less	4.0 or less	4.0 or less	Yes	
	Ryzner stability index	RSI	6.0 - 7.0	***	***	Yes	Yes

Water quality standard for chilled water

			Chilled water line		Tendency	
			Circulation T=<20C(68F)	Make up	Corrosion	Scale
Standard	pH(at 25C(77F))		6.5 - 8.0	6.0 - 8.0	Yes	Yes
	Electrical conductivity 25C	ms/m	40 or less	30 or less	Yes	Yes
	Chloride ion	mgCl ⁻ /l	50 or less	50 or less	Yes	
	Sulfuric acid ion	mgSO ₄ ²⁻ /l	50 or less	50 or less	Yes	
	Acid consumption pH 4.8	mgCaCO ₃ /l	50 or less	50 or less		Yes
	Total hardness	mgCaCO ₃ /l	70 or less	70 or less		Yes
	Calcium hardness	mgCaCO ₃ /l	50 or less	50 or less		Yes
	Ion silica	mgSiO ₂ /l	30 or less	30 or less		Yes
Reference	Iron	mgFe/l	1.0 or less	0.3 or less	Yes	Yes
	Copper	mgCu/l	1.0 or less	0.1 or less	Yes	
	Sulfide ion	mgS ²⁻ /l	No detected	No detected	Yes	
	Ammonium ion	mgNH ₄ ⁺ /l	1.0 or less	0.1 or less	Yes	
	Residual chlorine	mgCl/l	0.3 or less	0.3 or less	Yes	
	Free carbon dioxide	mgCO ₂ /l	4.0 or less	4.0 or less	Yes	
	Ryzner stability index	RSI	***	***	Yes	Yes

Water quality standard for hot water

			Hot water line				Tendency	
			20C(68F)=<T<60C(140F)		60C(140F)=<T<90C(194F)		Corrosion	Scale
			Circulation	Make up	Circulation	Make up		
Standard	pH(at 25C(77F))		7.0 - 8.0	7.0 - 8.0	7.0 - 8.0	7.0 - 8.0	Yes	Yes
	Electrical conductivity 25C	ms/m	30 or less	30 or less	30 or less	30 or less	Yes	Yes
	Chloride ion	mgCl ⁻ /l	50 or less	50 or less	30 or less	30 or less	Yes	
	Sulfuric acid ion	mgSO ₄ ²⁻ /l	50 or less	50 or less	30 or less	30 or less	Yes	
	Acid consumption pH 4.8	mgCaCO ₃ /l	50 or less	50 or less	50 or less	50 or less		Yes
	Total hardness	mgCaCO ₃ /l	70 or less	70 or less	70 or less	70 or less		Yes
	Calcium hardness	mgCaCO ₃ /l	50 or less	50 or less	50 or less	50 or less		Yes
	Ion silica	mgSiO ₂ /l	30 or less	30 or less	30 or less	30 or less		Yes
Reference	Iron	mgFe/l	1.0 or less	0.3 or less	1.0 or less	0.3 or less	Yes	Yes
	Copper	mgCu/l	1.0 or less	0.1 or less	1.0 or less	0.1 or less	Yes	
	Sulfide ion	mgS ²⁻ /l	No detected	No detected	No detected	No detected	Yes	
	Ammonium ion	mgNH ₄ ⁺ /l	0.3 or less	0.1 or less	0.1 or less	0.1 or less	Yes	
	Residual chlorine	mgCl/l	0.25 or less	0.3 or less	0.1 or less	0.3 or less	Yes	
	Free carbon dioxide	mgCO ₂ /l	0.4 or less	4.0 or less	0.4 or less	4.0 or less	Yes	
	Ryzner stability index	RSI	***	***	***	***	Yes	Yes

- (1) The item appellation and its definition and the unit belong to JIS K 0101.
- (2) The "yes" in the chart show the factor relevant to corrosion or scale genesis.
- (3) When high temperature (over 40°C);generally, using corrosive steel, materials which have no protective coating against water, anticorrosive measure shall be done such as adding corrosion prevention material, degasser and etc.
- (4) Under the Cooling water system with hermetically-closed cooling tower; the closed-circuit circulating water and its Makeup water are based on Hot water standard, spreading water and its Makeup water are based on circulating Cooling water system.
- (5) Supplied / replenished water needs to be tap water or industrial water or groundwater. Deionized water, regeneration treated water and softening treated water are excluded.
- (6) Upper15 items are shown as a typical factor for corrosion and/or scale genesis.

[Note 1] Each item of the standard values may cause a failure due to corrosion or scale and if any item deviates from the standard value, it is assumed that corrosion or scale tends to be caused, therefore, these should be periodically managed.

[Note 2] As the range of the water quality which may become usable if the water is processed differs depending on the chemicals to be used, it is not given here. It is desirable to set the appropriate water quality management values under the guidance of a water processing specialist and periodically manage the water quality.

6. Typical water treatment

Even if make-up water for cooling water meets the water standards, the water quality gets worse by its concentration, therefore the following water treatment is necessary. To varying degrees, chilled water also requires this treatment. In case of an application of concrete heat storage tank, special attention should be paid to water treatment.

- ① Periodic and continuous blow down by make-up water
- ② Automatic blow down by electric conductance
- ③ Addition of the anticorrosive
- ④ Slime control
- ⑤ Periodic water analysis

Overhaul the water headers periodically, check heat transfer tubes and clean them as necessary.

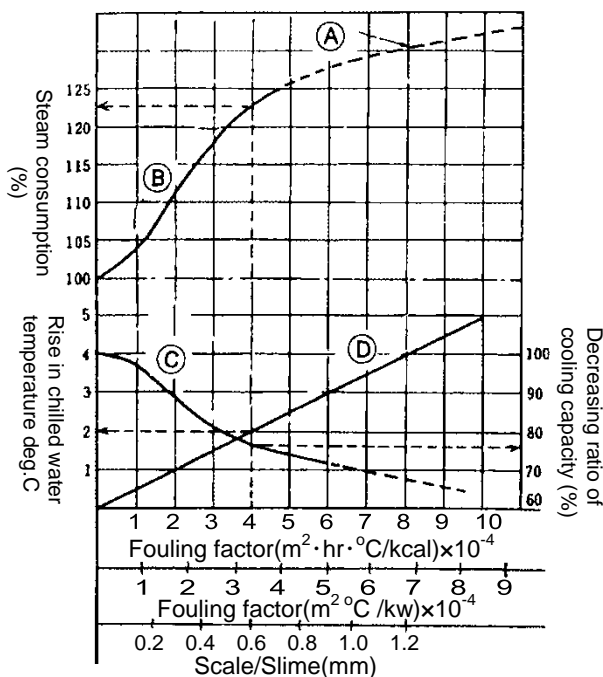

For example, if 0.6mm of scale clings to tube, cooling capacity drops to 76%, and chilled water temperature rises by 2°C (3.6°F) and fuel consumption rises by 23%.

A: In case of constant cooling capacity
(Ratio at rated fuel consumption)

B: Rise in fuel consumption

C: Lowering of cooling capacity
(In case of constant chilled water temperature)

D: Rise in chilled water temperature
(In case of constant cooling capacity)

5-3-2. Water Treatment for long term shut down

Perform the following treatment during long term shut down with no-circulation of chilled/hot water, cooling water in the Chiller. Consult the service agent for details.

(1) Cooling water

Keep the cooling water full in the Chiller. (Wet lay up)

In case the freezing of cooling water is likely to occur, drain it from the Chiller. (Dry lay up)

Operation of a valve of the chiller is different between wet lay up and dry lay up.

Wet lay up

1. Discharge cooling water from its discharge port on the cooling water outlet.
2. Check the holding water quantity and decide the anticorrosive quantity so that the mixture fraction is appropriate. Pour anticorrosive into the water.
3. Fill up the absorber/condenser.
4. Operate the cooling water pump until anticorrosive is evenly mixed.
5. Close the isolation valves of inlet and outlet on the cooling water line.

Dry lay up

1. Discharge cooling water from its discharge port on the cooling water outlet.
2. Remove the scale and/or slime adhesion in the tubes by nylon brush cleaning. (If scale and/or slime cannot be removed, perform chemical cleaning.)
3. After sufficient washing, pour anticorrosive into the water, and circulate it for 30 minutes or more. (The concentration of anticorrosive should be even.)

4. Discharge the water from the discharge port on the cooling water inlet.
5. Keep the discharge port open during shut down.

(2) Chilled water

Keep the evaporator full with the water. (Wet lay up)

(3) Hot water

Keep the generator full with the water. (Wet lay up)

5-3-3. Winter season

In case the ambient temperature of the Chiller is likely to be below 0°C, freeze protection is necessary.

Consult the service agent for details.

5-4. RECOMMENDED SCHEDULE FOR MAINTENANCE AND REPLACEMENT OF MAIN COMPONENTS

Parts division	Name of Parts	Replacement timing	Replacement cycle
Water line	Gasket of water line	After opening	
	Partition plate of water box	If necessary	
	Heat transfer tubes	Based on inspection result	
Body parts	Heat exchanger	If necessary	
	Absorbent ,Refrigerant	Based on inspection result	
	Refrigerant pan	If necessary	
	Service valve spindle	Periodic replacement	6 years
	Sight glass & packing	Periodic replacement	6 years
	Diaphragm packing	Periodic replacement	6 years
	Diaphragm valve	If necessary	
	Palladium cell	Periodic replacement	3 years
	Palladium cell heater	Periodic replacement	3 years
	Rupture disc	Periodic replacement	annual
	Angle valve	If necessary	
	Check valve	If necessary	
	Damper	If necessary	
Purge unit (ejector unit)	Periodic replacement	8 years	
Pump	Absorbent pump (#1 / #2)	Periodic replacement	10 years / 20,000h
	Refrigerant pump	Periodic replacement	10 years / 20,000h
	Purge pump	If necessary	
Control devices	Inverter(option)	Periodic replacement	5 years
	Fan for inverter(option)	Periodic replacement	3 years
	Reactor for inverter(option)	If necessary	
	Electromagnetic contactor	Periodic replacement	5 years
	Circuit breaker	If necessary	
	CPU, indicator, IO, power board	Periodic replacement	7 years
	Control relay	Periodic replacement	5 years
	Timer	Periodic replacement	5 years
	Cooling fan	Periodic replacement	5 years
	Generator temp. sensor	If necessary	
	Temp. sensor	If necessary	
	Pressure sensor	Periodic replacement	5 years
	Flow switch	Periodic replacement	8 years
Transformer	If necessary		

These replacement cycle have been assumed in consideration of performing a periodic maintenance.

6. MAINTENANCE CONTRACT

6-1. ANNUAL MAINTENANCE CONTRACT

Periodic inspection and parts replacement is important for safety operation. The inspection work requires a special skill. Please contact our service agent for details.

We are not responsible for any troubles that are caused by maintenance service performed by a non-specialist.

6-2. INSPECTION REPORT

We issue an inspection report when you make an annual maintenance contract.

In the report, the inspection items are written so that the service personnel will not overlook any of the inspection items. At inspection, the service personnel fill in the report, leave one copy with the customer, and take one copy back to the office so that they can use it for future maintenance works.

We will not re-issue this report, so please be sure to keep it in the fixed place and show it to the service personnel when they visit you.

6-3. WARRANTY

1. Service agent will hand it to you after filling in the warranty. Please confirm the warranty period, read it carefully and keep it in a safe place.
In case the Chiller fails within the warranty period under normal operating conditions, we will replace all the necessary spare parts or repair the Chiller free of charge. Tube cleaning is fare-paying service.
2. After the warranty period expires, all repair costs will be charged. Consult the service agent.
3. As for other items, please read the warranty agreement.

Manufacturer
CARRIER SCS
Route de Thil - BP49
01122 MONTLUEL CEDEX, FRANCE