



INSTALLATION, OPERATION AND MAINTENANCE INSTRUCTIONS



Unit with options 15 & 23A

Air-Cooled Screw Chillers

30XB - 30XBP

Nominal cooling capacity: 270 - 1688 kW - 50Hz



CONTENTS

1 - INTRODUCTION	4
1.1 - Installation safety considerations	4
1.2 - Equipment and components under pressure	5
1.3 - Maintenance safety considerations	5
1.4 - Repair safety considerations	6
2 - PRELIMINARY CHECKS	8
2.1 - Check equipment received	8
2.2 - Moving and siting the unit.....	8
3 - DIMENSIONS, CLEARANCES	10
3.1 - 30XB-250 to 350, 30XBP-250 to 350, 30XB-250 to 300 with option 254/255.....	10
3.2 - 30XB-400 to 450, 30XBP-400 to 500, 30XB-350 to 400 with option 254/255.....	10
3.3 - 30XBP-500, 30XB-500 with options 254/255, 50 (heat recovery) or 118A (free cooling).....	11
3.4 - 30XB-600 to 900, 30XBP-600 to 800, 30XB-600 to 700 with option 254/255.....	11
3.5 - 30XB-1000, 30XBP-850 to 900, 30XB-750 to 850 with option 254/255.....	12
3.6 - 30XBP-1000, 30XB-900 option 254/255, 30XB-1000 with options 50 (heat recovery) & 118 (free cooling).....	12
3.7 - 30XB-1100 to 1400, 30XBP-1100 to 1400	13
3.8 - 30XB-1500, 30XBP-1500	13
3.9 - 30XB-1550 module 1/2.....	14
3.10 - 30XB-1550 module 2/2.....	14
3.11 - 30XB-1700 module 1/2	15
3.12 - 30XB-1700 module 2/2.....	15
3.13 - Multiple chiller installation.....	16
3.14 - Distance to the wall	16
4 - PHYSICAL AND ELECTRICAL DATA FOR 30XB UNITS	17
4.1 - Physical data 30XB	17
4.2 - Physical data 30XBP.....	21
4.3 - Physical data 30XB with option 254 or 255.....	25
4.4 - Short-circuit stability current for all units.....	28
4.5 - Electrical data.....	29
4.6 - Compressor electrical data.....	36
4.7 - Compressor usage per circuit (A, B, C, D).....	37
4.8 - Electrical data, optional hydraulic module	38
5 - ELECTRICAL CONNECTION	39
5.1 - Power supply	39
5.2 - Voltage phase imbalance (%).....	39
5.3 - Power connection/disconnect switch.....	39
5.4 - Recommended wire sections	39
5.5 - Power cable entry.....	39
5.6 - Field control wiring	40
6 - APPLICATION DATA	41
6.1 - Operating range	41
6.2 - Minimum chilled water flow (units without hydraulic module).....	41
6.3 - Maximum chilled water flow (units without hydraulic module).....	41
6.4 - Variable flow evaporator	42
6.5 - System minimum water volume	42
6.6 - Maximum system water volume	42
6.7 - Evaporator water flow rate	42
6.8 - Evaporator pressure drop curve.....	43
7 - WATER CONNECTIONS	44
7.1 - Operating precautions	44
7.2 - Victaulic water connections	45
7.3 - Flow control	46
7.4 - Evaporator water box bolt tightening.....	46
7.5 - Frost protection	46
7.6 - Operation of two units in master/slave mode (option 58).....	46
7.7 - Pump characteristics	47
8 - FREE-COOLING OPTION (OPTION 118A)	49
8.1 - Physical data, 30XB units with free-cooling option (option 118A).....	49
8.2 - Operating limits	49
8.3 - Operation.....	49

CONTENTS

9 - HEAT RECLAIM CONDENSER OPTION (OPTION 50)	50
9.1 - Physical data,30XB & XBP units with heat reclaim condenser option	50
9.2 - Dimensions, clearances	50
9.3 - Condenser location	54
9.4 - Condenser water connections.....	54
9.5 - Operating limits for stable operation (no mode changeover)	54
9.6 - Operating limits for changeover between modes	54
9.7 - Flow control.....	55
9.8 - Heat reclaim operation	55
9.9 - Condenser pump selection.....	55
9.10 - Frost protection	55
10 - FANS WITH AVAILABLE PRESSURE (OPTION 10)	56
11 - MAJOR SYSTEM COMPONENTS AND OPERATION DATA	57
11.1 - Direct-drive twin-screw compressor with variable capacity slide valve	57
11.2 - Pressure vessels	57
11.3 - High-pressure safety switch	58
11.4 - Condensers	58
11.5 - Fans.....	58
11.6 - Electronic expansion valve (EXV)	59
11.7 - Moisture indicator	59
11.8 - Filter drier	59
11.9 - Sensors	59
11.10 - Service valve (option 92).....	59
11.11 - Power factor correction capacitors (option 231)	59
12 - MAIN OPTIONS	61
13 - STANDARD MAINTENANCE	63
13.1 - Level 1 maintenance	63
13.2 - Level 2 maintenance	63
13.3 - Level 3 (or higher) maintenance.....	63
13.4 - Tightening torques for the main electrical connections	63
13.5 - Tightening torques for the main bolts and screws.....	64
13.6 - Condenser coil	64
13.7 - Evaporator maintenance	65
13.8 - Compressor maintenance	65
13.9 - Precaution for compressor power supply bus bar connection.....	66
13.10 - Check of power factor correction capacitors	66
14 - START-UP CHECKLIST FOR 30XB LIQUID CHILLERS (USE FOR JOB FILE)	67

The illustrations on the front cover and inside this document are for illustrative purposes only and not part of any offer for sale or contract.

1 - INTRODUCTION

The AquaForce™ 30XB and 30XBP units are designed to cool water for the air conditioning of buildings and industrial processes.

Prior to the initial start-up of the 30XB units, the people involved in the on-site installation, start-up, operation, and maintenance of this unit should be thoroughly familiar with these instructions and the specific project data for the installation site.

They are designed for an operating life of 15 years by assuming a 75% utilisation factor; that is approximately 100,000 operating hours.

The 30XB liquid chillers are designed to provide a very high level of safety during installation, start-up, operation and maintenance. They will provide safe and reliable service when operated within their application range.

This manual provides the necessary information to familiarize yourself with the control system before performing start-up procedures. The procedures in this manual are arranged in the sequence required for machine installation, start-up, operation and maintenance.

Always ensure that all required safety measures are followed, including those in this document, such as, wearing protective clothing (gloves, ear defenders, safety glasses and shoes), using appropriate tools, employing qualified and skilled technicians (electricians, refrigeration engineers) and following local regulations.

To find out, if these products comply with European directives (machine safety, low voltage, electromagnetic compatibility, equipment under pressure etc.) check the declarations of conformity for these products.

1.1 - Installation safety considerations

Access to the unit must be reserved to authorised personnel, qualified and trained in monitoring and maintenance. The access limitation device must be installed by the customer (e.g. cut-off, enclosure).

After the unit has been received, when it is ready to be installed or reinstalled, and before it is started up, it must be inspected for damage. Check that the refrigerant circuit(s) is (are) intact, especially that no components or pipes have shifted (e.g. following a shock). If in doubt, carry out a leak tightness check and verify with the manufacturer that the circuit integrity has not been impaired. If damage is detected upon receipt, immediately file a claim with the shipping company.

Carrier strongly recommends employing a specialised company to unload the machine.

Do not remove the skid or the packaging until the unit is in its final position. These units can be moved with a fork lift truck, as long as the forks are positioned in the right place and direction on the unit.

The units can also be lifted with slings, using only the designated lifting points marked on the unit.

These units are not designed to be lifted from above. Use slings with the correct capacity, and always follow the lifting instructions on the certified drawings supplied with the unit.

Safety is only guaranteed, if these instructions are carefully followed. If this is not the case, there is a risk of material deterioration and injuries to personnel.

DO NOT COVER ANY PROTECTION DEVICES.

This applies to fuse plugs and relief valves (if used) in the refrigerant or heat transfer medium circuits. Check if the original protection plugs are still present at the valve outlets. These plugs are generally made of plastic and should not be used. If they are still present, please remove them. Install devices at the valve outlets or drain piping that prevent the penetration of foreign bodies (dust, building debris, etc.) and atmospheric agents (water can form rust or ice). These devices, as well as the drain piping, must not impair operation and not lead to a pressure drop that is higher than 10% of the control pressure.

Classification and control

In accordance with the Pressure Equipment Directive and national usage monitoring regulations in the European Union the protection devices for these machines are classified as follows:

	Safety accessory ⁽¹⁾	Over pressure protection in case of an external fire ⁽²⁾
Refrigerant Side		
High pressure switch	X	
External relief valve ⁽³⁾		X
Rupture disk		X
Fuse plug		X
Heat transfer fluid side		
External relief valve	(4)	(4)

(1) Classified for protection in normal service situations.

(2) Classified for protection in abnormal service situations. These accessories are sized for fires with a thermal flow of 10kW/m². No combustible matter should be placed within 6.5m of the unit.

(3) The instantaneous overpressure limitation of 10% of the operating pressure does not apply to this abnormal service situation.

The control pressure can be higher than the service pressure. In this case, either the design temperature or the high pressure switch ensures that the service pressure is not exceeded in normal service situations.

(4) The selection of these relief valves must be made by the personnel responsible for completing the hydraulic installation.

Do not remove these valves and fuses, even if the fire risk is under control for a particular installation. There is no guarantee that the accessories are re-installed if the installation is changed or for transport with a gas charge.

When the unit is subjected to fire, safety devices prevent rupture due to over-pressure by releasing the refrigerant. The fluid may then be decomposed into toxic residues when subjected to the flame:

- Stay away from the unit.
- Set up warnings and recommendations for personnel in charge to stop the fire.
- Fire extinguishers appropriate to the system and the refrigerant type must be easily accessible

All factory-installed relief valves are lead-sealed to prevent any calibration change. If the relief valves are installed on a change-over valve, this is equipped with a relief valve on each of the two outlets. Only one of the two relief valves is in operation, the other one is isolated. Never leave the change-over valve in the intermediate position, i.e. with both ways open (Bring the actuator in abutment, front or back according to the outlet to isolate).

If a relief valve is removed for checking or replacement please ensure that there is always an active relief valve on each of the change-over valves installed in the unit.

The external relief valves must always be connected to drain pipes for units installed in a closed room. Refer to the installation regulations, for example those of European standard EN 378 and EN 13136.

1 - INTRODUCTION

These pipes must be installed in a way that ensures that people and property are not exposed to refrigerant leaks. As the fluids can be diffused in the air, ensure that the outlet is far away from any building air intake, or that they are discharged in a quantity that is appropriate for a suitably absorbing environment.

Periodic check of the relief valves: See chapter 1.3 - "Maintenance safety considerations".

Provide a drain in the drain pipe, close to each relief valve, to avoid an accumulation of condensate or rain water.

All precautions concerning handling of refrigerant must be observed in accordance with local regulations.

Ensure good ventilation, as accumulation of refrigerant in an enclosed space can displace oxygen and cause asphyxiation or explosions.

Inhalation of high concentrations of vapour is harmful and may cause heart irregularities, unconsciousness, or death. Vapour is heavier than air and reduces the amount of oxygen available for breathing. These products cause eye and skin irritation. Decomposition products are hazardous.

1.2 - Equipment and components under pressure

These products incorporate equipment or components under pressure, manufactured by Carrier or other manufacturers. We recommend that you consult your appropriate national trade association or the owner of the equipment or components under pressure (declaration, re-qualification, retesting, etc.). The characteristics of this equipment/these components are given on the nameplate or in the required documentation, supplied with the products.

These units are intended to be stored and operated in an environment where the ambient temperature must be not less than the lowest allowable temperature indicated on the nameplate.

Do not introduce significant static or dynamic pressure with regard to the operating pressures used during operation or for tests in the refrigerant circuit or in the heat exchange circuits.

See section "11.2 - Pressure vessels".

1.3 - Maintenance safety considerations

Carrier recommends the following drafting for a logbook (the table below should not be considered as reference and does not involve Carrier responsibility):

Intervention		Name of the commissioning engineer	Applicable national regulations	Verification Organism
Date	Nature ⁽¹⁾			

(1) Maintenance, repairs, regular verifications (EN 378), leakage, etc. Engineers working on the electric or refrigeration components must be authorized, trained and fully qualified to do so.

All refrigerant circuit repairs must be carried out by a trained person, fully qualified to work on these units. He must have been trained and be familiar with the equipment and the installation. All welding operations must be carried out by qualified specialists.

Any manipulation (opening or closing) of a shut-off valve must be carried out by a qualified and authorised engineer. These procedures must be carried out with the unit shut-down.

NOTE: The unit must never be left shut down with the liquid line valve closed, as liquid refrigerant can be trapped between this valve and the expansion device and lead to the risk of a pressure increase. This valve is situated on the liquid line before the filter drier box.

During any handling, maintenance and service operations the engineers working on the unit must be equipped with safety gloves, glasses, shoes and protective clothing.

Never work on a unit that is still energized.

Never work on any of the electrical components, until the general power supply to the unit has been cut using the disconnect switch(es) in the control box(es).

If any maintenance operations are carried out on the unit, lock the power supply circuit in the open position ahead of the machine.

If the work is interrupted, always ensure that all circuits are still deenergized before resuming the work.

ATTENTION: Even if the unit has been switched off, the power circuit remains energized, unless the unit or circuit disconnect switch is open. Refer to the wiring diagram for further details. Attach appropriate safety labels.

Units with option 231 are equipped with capacitor batteries with a discharge time of five (5) minutes after disconnecting the power. After disconnecting the power to the control box, wait five minutes before opening the control box. Before any intervention, verify that there is no voltage present at any accessible conducting parts of the power circuit.

OPERATING CHECKS:

Important information regarding the refrigerant used:

- *This product contains fluorinated greenhouse gas covered by the Kyoto protocol.*

Fluid type: R134a

Global Warming Potential (GWP): 1430

CAUTION:

- Any intervention on the refrigerant circuit of this product should be performed in accordance with the applicable legislation. In the EU, the regulation is called F-Gas, N°517/2014*
- Ensure that the refrigerant is never released to the atmosphere during installation, maintenance or equipment disposal.*
- The deliberate gas release into the atmosphere is not allowed.*
- If a refrigerant leak is detected, ensure that it is stopped and repaired as quickly as possible.*
- Only a qualified and certified personnel can perform installation operations, maintenance, refrigerant circuit leak test as well as the equipment disposal and the refrigerant recovering.*
- The gas recovery for recycling, regeneration or destruction is at customer charge.*

1 - INTRODUCTION

7. Periodic leak tests have to be carried out by the customer or by third parties. The EU regulation set the periodicity here after:

System WITHOUT leakage detection	No Check	12 Months	6 Months	3 Months	
System WITH leakage detection	No Check	24 Months	12 Months	6 Months	
Refrigerant charge/ circuit (CO ₂ equivalent)	< 5 Tons	5 ≤ Charge < 50 Tons	50 ≤ Charge < 500 Tons	Charge > 500 Tons*	
Refrigerant charge/ Circuit (kg)	R134A (GWP 1430)	Charge < 3.5 kg	3.5 ≤ Charge < 34.9 kg	34.9 ≤ Charge < 349.7 kg	Charge > 349.7 kg
	R407C (GWP 1774)	Charge < 2.8 kg	2.8 ≤ Charge < 28.2 kg	28.2 ≤ Charge < 281.9 kg	Charge > 281.9 kg
	R410A (GWP 2088)	Charge < 2.4 kg	2.4 ≤ Charge < 23.9 kg	23.9 ≤ Charge < 239.5 kg	Charge > 239.5 kg
	HFO's: R1234ze	No requirement			

* From 01/01/2017, units must be equipped with a leakage detection system

8. A logbook must be established for equipments subject to periodic leak tests. It should contain the quantity and the type of fluid present within the installation (added and recovered), the quantity of recycled fluid, regenerated or destroyed, the date and output of the leak test, the designation of the operator and its belonging company, etc.

9. Contact your local dealer or installer if you have any questions.

The information on operating inspections given in annex C of standard EN 378 can be used if no similar criteria exist in the national regulations.

While working in the fan area, especially when grilles or casings are removed, disconnect the fan power supply to prevent their automatic restart.

PROTECTION DEVICE CHECKS:

- If no national regulations exist, check the protection devices on site in accordance with standard EN 378: Once a year for the high-pressure switches, every five years for external relief valves.

The company or organisation that conducts a pressure switch test must establish and implement detailed procedures for:

- Safety measures
- Measuring equipment calibration
- Validating operation of protective devices
- Test protocols
- Recommissioning of the equipment.

Consult Carrier Service for this type of test. Carrier mentions here only the principle of a test without removing the pressure switch:

- Verify and record the set-points of pressure switches and relief devices (valves and possible rupture discs)
- Be ready to switch-off the main disconnect switch of the power supply if the pressure switch does not trigger (avoid over-pressure or excess gas in case of valves on the high-pressure side with the recovery condensers)
- Connect a pressure gauge protected against pulsations (filled with oil with maximum pointer if mechanical), preferably calibrated (the values displayed on the user interface may be inaccurate in an instant reading because of the scanning delay applied in the control)
- Complete an HP Test as provided by the software (refer to the Control IOM for details).

If the machine operates in a corrosive environment, inspect the protection devices more frequently.

Regularly carry out leak tests and immediately repair any leaks. Ensure regularly that the vibration levels remain acceptable and close to those at the initial unit start-up.

Before opening a refrigerant circuit, purge and consult the pressure gauges.

Change the refrigerant after an equipment failure, following a procedure such as the one described in NF E29-795 or carry out a refrigerant analysis in a specialist laboratory.

Plug all openings whenever the refrigerant circuit is opened for up to one day. For longer openings place a nitrogen charge in the circuit.

1.4 - Repair safety considerations

All installation parts must be maintained by the personnel in charge, in order to avoid material deterioration and injuries to people. Faults and leaks must be repaired immediately. The authorized technician must have the responsibility to repair the fault immediately. After each repair of the unit, check the operation of the protection devices and create a report of the parameter operation at 100%.

Comply with the regulations and recommendations in unit and HVAC installation safety standards, such as: EN 378, ISO 5149, etc.

If a leak occurs or if the refrigerant becomes contaminated (e.g. by a short circuit in a motor) remove the complete charge using a recovery unit and store the refrigerant in mobile containers.

Repair the leak detected and recharge the circuit with the total R-134a charge, as indicated on the unit name plate. Certain parts of the circuit can be isolated. Only charge liquid refrigerant R-134a at the liquid line.

Ensure that you are using the correct refrigerant type before recharging the unit. Charging any refrigerant other than the original charge type (R-134a) will impair machine operation and even destroy the compressors. The compressors operating with this refrigerant type are lubricated with a synthetic polyolester oil.

RISK OF EXPLOSION:



Never use air or a gas containing oxygen during leak tests to purge lines or to pressurise a machine. Pressurised air mixtures or gases containing oxygen can be the cause of an explosion.

Only use dry nitrogen for leak tests, possibly with an appropriate tracer gas.

If the recommendations above are not observed, this can have serious or even fatal consequences and damage the installation.

Never exceed the specified maximum operating pressures. Verify the allowable maximum high- and low-side test pressures by checking the instructions in this manual and the pressures given on the unit name plate.

Do not unweld or flamecut the refrigerant lines or any refrigerant circuit component until all refrigerant (liquid and vapour) as well as the oil have been removed from chiller. Traces of vapour should be displaced with dry air nitrogen. Refrigerant in contact with an open flame produces toxic gases.

The necessary protection equipment must be available, and appropriate fire extinguishers for the system and the refrigerant type used must be within easy reach.

Do not siphon refrigerant.

1 - INTRODUCTION

Avoid spilling liquid refrigerant on skin or splashing it into the eyes. Use safety goggles and safety gloves. Wash any spills from the skin with soap and water. If liquid refrigerant enters the eyes, immediately and abundantly flush the eyes with water and consult a doctor.

The accidental releases of the refrigerant, due to small leaks or significant discharges following the rupture of a pipe or an unexpected release from a safety valve, can cause frostbites and burns to personnel exposed. Do not ignore such injuries. Installers, owners and especially service engineers for these units must:

- **Seek medical attention before treating such injuries.**
- **Have access to a first-aid kit, especially for treating eye injuries.**

We recommend to apply standard EN 378-3 Annex 3.

Never apply an open flame or live steam to a refrigerant container. Dangerous overpressure can result. If it is necessary to heat refrigerant, use only warm water.

During refrigerant removal and storage operations follow applicable regulations. These regulations, permitting conditioning and recovery of halogenated hydrocarbons under optimum quality conditions for the products and optimum safety conditions for people, property and the environment are described in standard NF E29-795.

Any refrigerant transfer and recovery operations must be carried out using a transfer unit. A 3/8" SAE connector on the manual liquid line valve is supplied with all units for connection to the transfer station. The units must never be modified to add refrigerant and oil charging, removal and purging devices. All these devices are provided with the units. Please refer to the certified dimensional drawings for the units.

Do not re-use disposable (non-returnable) cylinders or attempt to refill them. It is dangerous and illegal. When cylinders are empty, evacuate the remaining gas pressure, and move the cylinders to a place designated for their recovery. Do not incinerate them.

ATTENTION: Only use refrigerant R134a, in accordance with 700 AHRI (Air conditioning, Heating and Refrigeration Institute). The use of any other refrigerant may expose users and operators to unexpected risks.

Do not attempt to remove refrigerant circuit components or fittings, while the machine is under pressure or while it is running. Be sure pressure is at 0 kPa and that the unit has been shut-down and de-energised before removing components or opening a circuit.

Do not attempt to repair or recondition any safety devices when corrosion or build-up of foreign material (rust, dirt, scale, etc.) is found within the valve body or mechanism. If necessary, replace the device. Do not install relief valves in series or backwards.

ATTENTION: No part of the unit must be used as a walk-way, rack or support. Periodically check and repair or if necessary replace any component or piping that shows signs of damage.

The refrigerant lines can break under the weight and release refrigerant, causing personal injury.

Do not climb on a machine. Use a platform, or staging to work at higher levels.

Use mechanical lifting equipment (crane, hoist, winch, etc.) to lift or move heavy components. For lighter components, use lifting equipment when there is a risk of slipping or losing your balance.

Use only original replacement parts for any repair or component replacement. Consult the list of replacement parts that corresponds to the specification of the original equipment.

Do not drain water circuits containing industrial brines, without informing the technical service department at the installation site or a competent body first.

Close the entering and leaving water shutoff valves and purge the unit water circuit, before working on the components installed on the circuit (screen filter, pump, water flow switch, etc.).

Do not loosen the water box bolts until the water boxes have been completely drained.

Periodically inspect all valves, fittings and pipes of the refrigerant and hydraulic circuits to ensure that they do not show any corrosion or any signs of leaks.

It is recommended to wear ear defenders, when working near the unit and the unit is in operation.

2 - PRELIMINARY CHECKS

2.1 - Check equipment received

- Check that the unit has not been damaged during transport and that no parts are missing. If the unit has been damaged or the shipment is incomplete, send a claim to the shipping company.
- Compare the name plate data with the order. The name plate is attached in two places to the unit:
 - On one of the unit sides on the outside,
 - On the control box door on the inside.
- The unit name plate must include the following information:
 - Version number
 - Model number
 - CE marking
 - Serial number
 - Year of manufacture and test date
 - Fluid being transported
 - Refrigerant used and refrigerant class
 - Refrigerant charge per circuit
 - Containment fluid to be used
 - **PS:** Min./max. allowable pressure (high and low pressure side)
 - **TS:** Min./max. allowable temperature (high and low pressure side)
 - Pressure switch cut-out pressure
 - Unit leak test pressure
 - Voltage, frequency, number of phases
 - Maximum current drawn
 - Maximum power input
 - Unit net weight
- Confirm that all accessories ordered for on-site installation have been supplied, are complete and undamaged.

The unit must be checked periodically during its whole operating life to ensure that no shocks (handling accessories, tools etc.) have damaged it. If necessary, damaged parts must be repaired or replaced. See also chapter 13 - "Standard maintenance".

2.2 - Moving and siting the unit

2.2.1 - Moving

See chapter 1.1 "Installation safety considerations".

In some cases vertical supports are added for the transport and handling of the unit. These supports can be removed for access or connection, if required.

IMPORTANT: Follow the disassembly sequence shown in the disassembly instruction notes.

NOTE:

- **Screw off item: 1**
- **Loosen screw item: 2**
- **Raise and remove frame post item: 3**
- **Screw off item: 4 and remove reinforcement plate item: 5**

Keep the vertical supports after commissioning the units and re-insert them when the unit is moved.

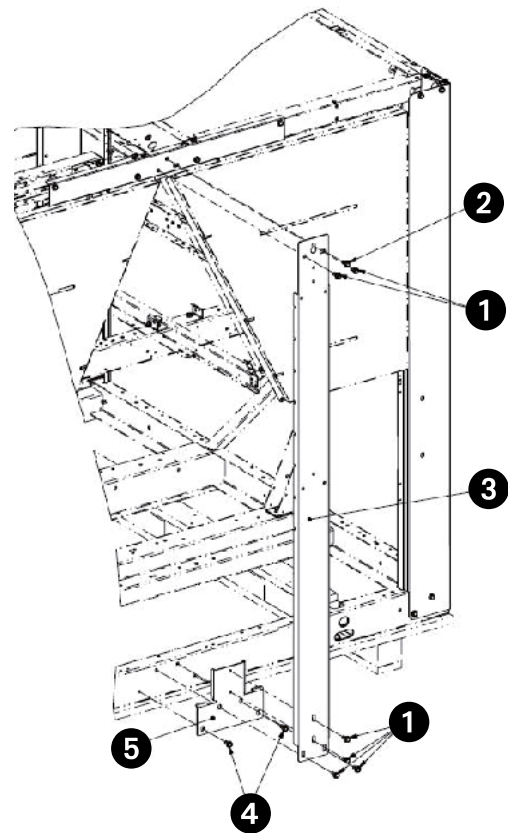

2 - PRELIMINARY CHECKS

2.2.2 - Siting the unit

The machine must be installed in a place that is not accessible to the public or protected against access by non-authorised persons.

In case of extra-high units the machine environment must permit easy access for maintenance operations.

Always refer to the chapter 3 "Dimensions, clearances" to confirm that there is adequate space for all connections and service operations. For the centre of gravity coordinates, the position of the unit mounting holes, and the weight distribution points, refer to the certified dimensional drawing supplied with the unit.

The support points under the chassis must have at least the size of the chassis opening at the lifting point (minimum 220 x 180 mm) in order to prevent a deformation of the chassis.

Typical applications of these units are in refrigeration systems, and they do not require earthquake resistance. Earthquake resistance has not been verified.

CAUTION: Only use slings at the designated lifting points which are marked on the unit.

Before siting the unit check that:

- The permitted loading at the site is adequate or that appropriate strengthening measures have been taken.
- The unit is installed level on an even surface (maximum tolerance is 5 mm in both axes).
- There is adequate space above the unit for air flow and to ensure access to the components.
- The number of support points is adequate and that they are in the right places.
- The location is not subject to flooding.
- For outdoor installations, where heavy snowfall is likely and long periods of sub-zero temperatures are normal, provision has to be made to prevent snow accumulating by raising the unit above the height of drifts normally experienced.
- Baffles may be necessary to deflect strong winds. They must not restrict air flow into the unit.

CAUTION: Before lifting the unit, check that all casing panels are securely fixed in place. Lift and set down the unit with great care. Tilting and jarring can damage the unit and impair unit operation.

If 30XB units are hoisted with rigging, it is advisable to protect coils against crushing while a unit is being moved. Use struts or spreader bar to spread the slings above the unit. Do not tilt a unit more than 15°.

WARNING: Never push or lever on any of the enclosure panels of the unit. Only the base of the unit frame is designed to withstand such stresses.

If a unit includes a hydraulic module (options 116B, C, F, G), the hydraulic module and pump piping must be installed in a way that does not submit it to any strain. The hydraulic module pipes must be fitted so that the pump does not support the weight of the pipes.

2.2.3 - Checks before system start-up

Before the start-up of the refrigeration system, the complete installation, including the refrigeration system must be verified against the installation drawings, dimensional drawings, system piping and instrumentation diagrams and the wiring diagrams.

For these checks national regulations must be followed. If the national regulation does not specify any details, refer to standard EN 378 as follows:

External visual installation checks:

- Ensure that the machine is charged with refrigerant. Verify on the unit nameplate that the 'fluid transported' is R134A and is not nitrogen.
- Compare the complete installation with the refrigeration system and power circuit diagrams.
- Check that all components comply with the design specifications.
- Check that all protection documents and equipment provided by the manufacturer (dimensional drawings, P&ID, declarations etc.) to comply with the regulations are present.
- Verify that the environmental safety and protection and devices and arrangements provided by the manufacturer to comply with the regulations are in place.
- Verify that all documents for pressure containers, certificates, name plates, files, instruction manuals provided by the manufacturer to comply with the regulations are present.
- Verify the free passage of access and safety routes.
- Check that ventilation in the plant room is adequate.
- Check that refrigerant detectors are present.
- Verify the instructions and directives to prevent the deliberate removal of refrigerant gases that are harmful to the environment.
- Verify the installation of connections.
- Verify the supports and fixing elements (materials, routing and connection).
- Verify the quality of welds and other joints.
- Check the protection against mechanical damage.
- Check the protection against heat.
- Check the protection of moving parts.
- Verify the accessibility for maintenance or repair and to check the piping.
- Verify the status of the valves.
- Verify the quality of the thermal insulation and of the vapour barriers.

3 - DIMENSIONS, CLEARANCES

3.1 - 30XB-250 to 350, 30XBP-250 to 350, 30XB-250 to 300 with option 254/255

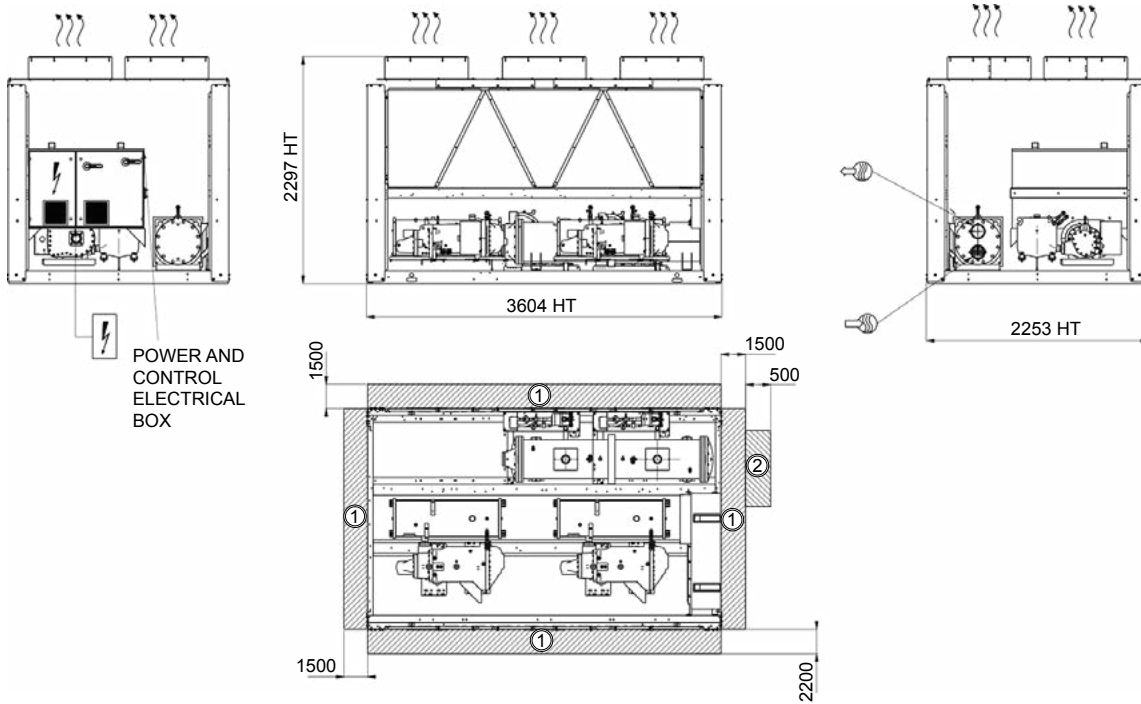



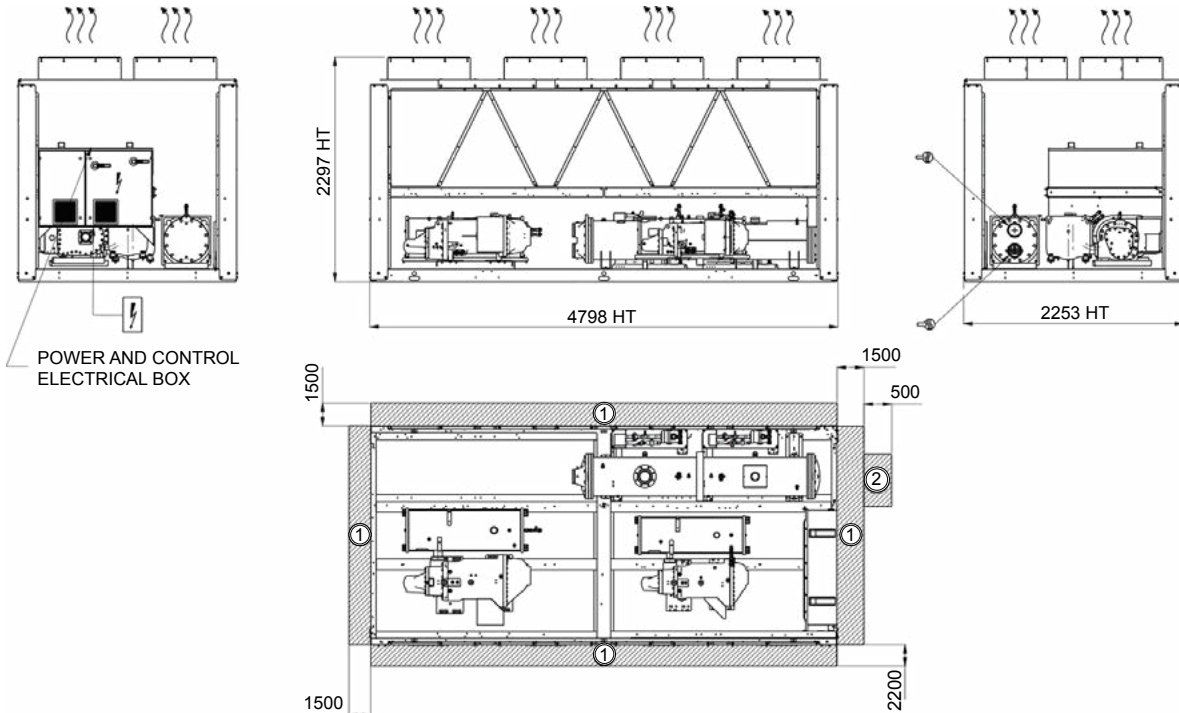

3.2 - 30XB-400 to 450, 30XBP-400 to 500, 30XB-350 to 400 with option 254/255



Legend

All dimensions are given in mm.

- ① Required clearances for maintenance (see note)
- ② Recommended space for evaporator tube removal
-  Water inlet for standard unit
For options 5, 6, 100A, 100C, 107 refer to the certified drawing.
-  Water inlet for standard unit
For options 5, 6, 100A, 100C, 107 refer to the certified drawing.
-  Air outlet – do not obstruct
-  Power supply and control connection

NOTES:

- Drawings are not contractually binding.
- Before designing an installation, consult the certified dimensional drawings, available on request.
- For the positioning of the fixing points, weight distribution and centre of gravity coordinates please refer to the dimensional drawings.
- If the installation includes several units or if this (these) is (are) close to walls, please refer to chapters 3.12 - "Multiple chiller installation" and 3.13 - "Distance to the wall" of this document to determine the space required.

3 - DIMENSIONS, CLEARANCES

3.3 - 30XPB-500, 30XB-500 with options 254/255, 50 (heat recovery) or 118A (free cooling)

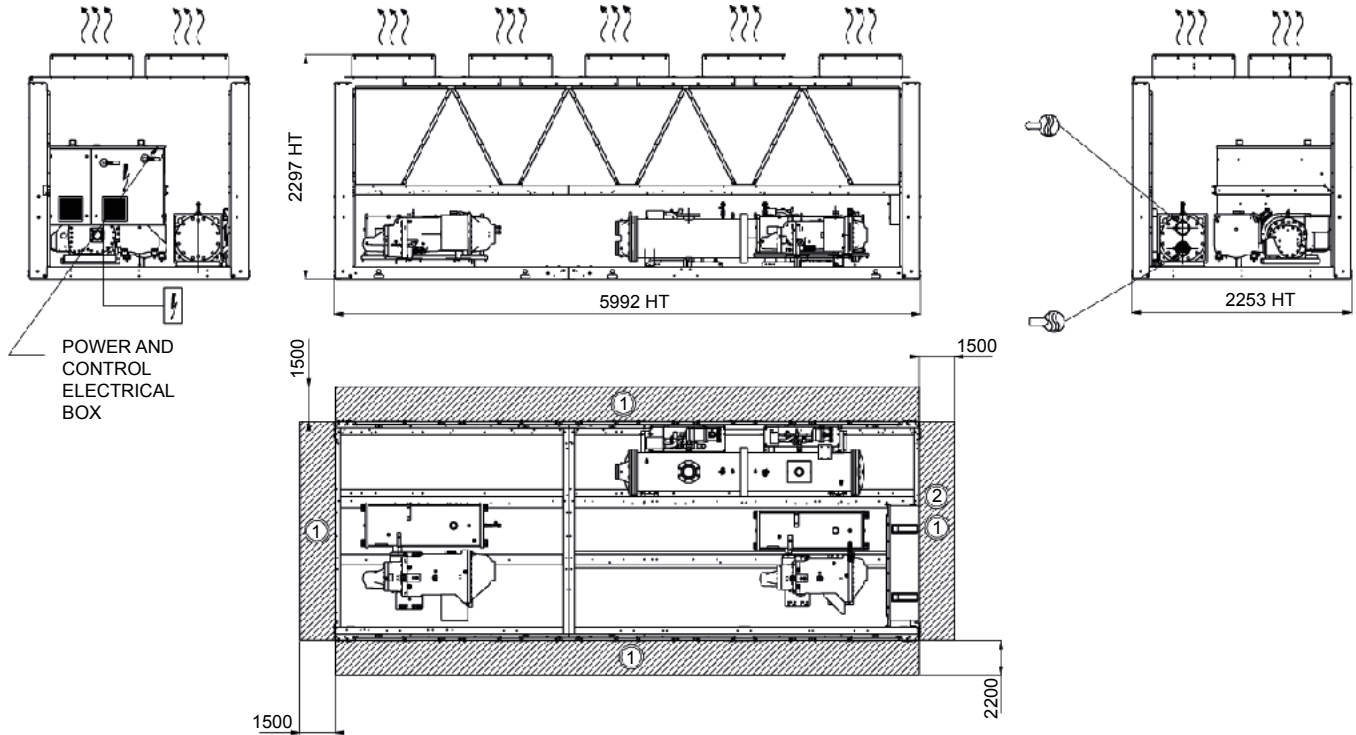

3.4 - 30XB-600 to 900, 30XPB-600 to 800, 30XB-600 to 700 with option 254/255

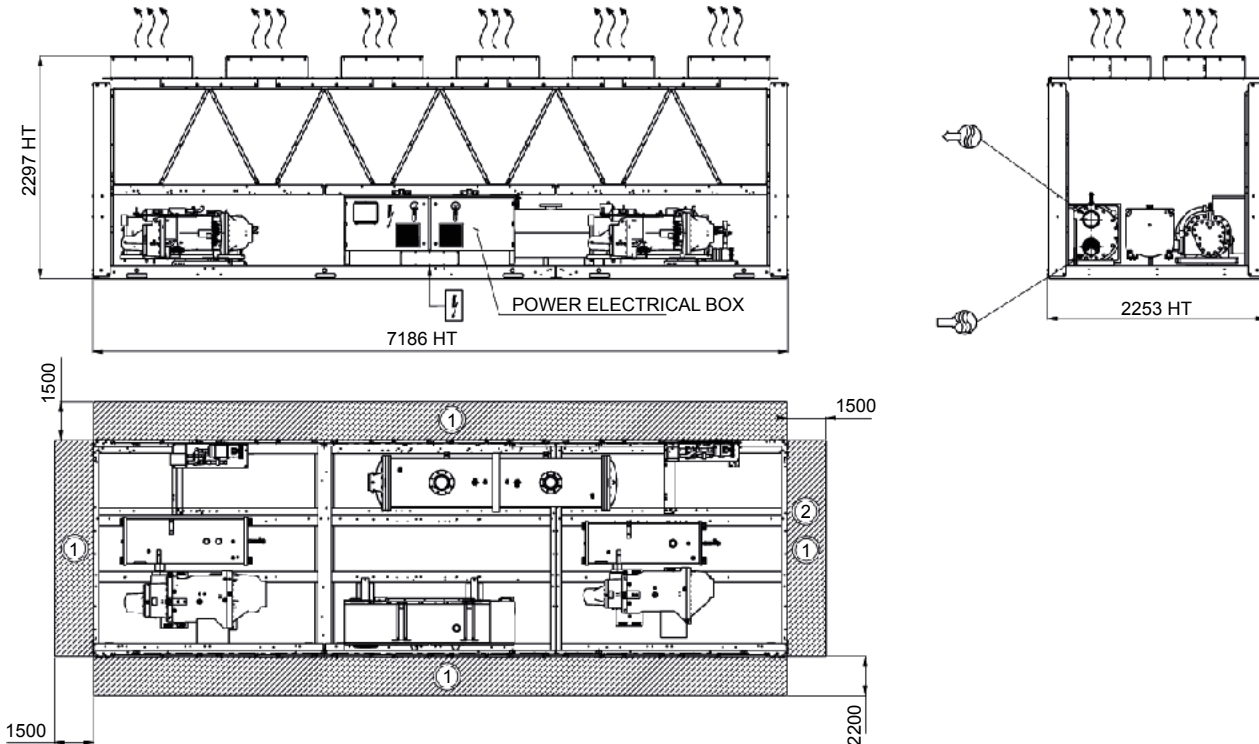

Legend

All dimensions are given in mm.

- ① Required clearances for maintenance (see note)
- ② Recommended space for evaporator tube removal
- Water inlet for standard unit
For options 5, 6, 100A, 100C, 107 refer to the certified drawing.
- Water inlet for standard unit
For options 5, 6, 100A, 100C, 107 refer to the certified drawing.
- Air outlet – do not obstruct
- Power supply and control connection

NOTES:

- Drawings are not contractually binding.
- Before designing an installation, consult the certified dimensional drawings, available on request.
- For the positioning of the fixing points, weight distribution and centre of gravity coordinates please refer to the dimensional drawings.
- If the installation includes several units or if this (these) is (are) close to walls, please refer to chapters 3.12 - "Multiple chiller installation" and 3.13 - "Distance to the wall" of this document to determine the space required.

3 - DIMENSIONS, CLEARANCES

3.5 - 30XB-1000, 30XBP-850 to 900, 30XB-750 to 850 with option 254/255

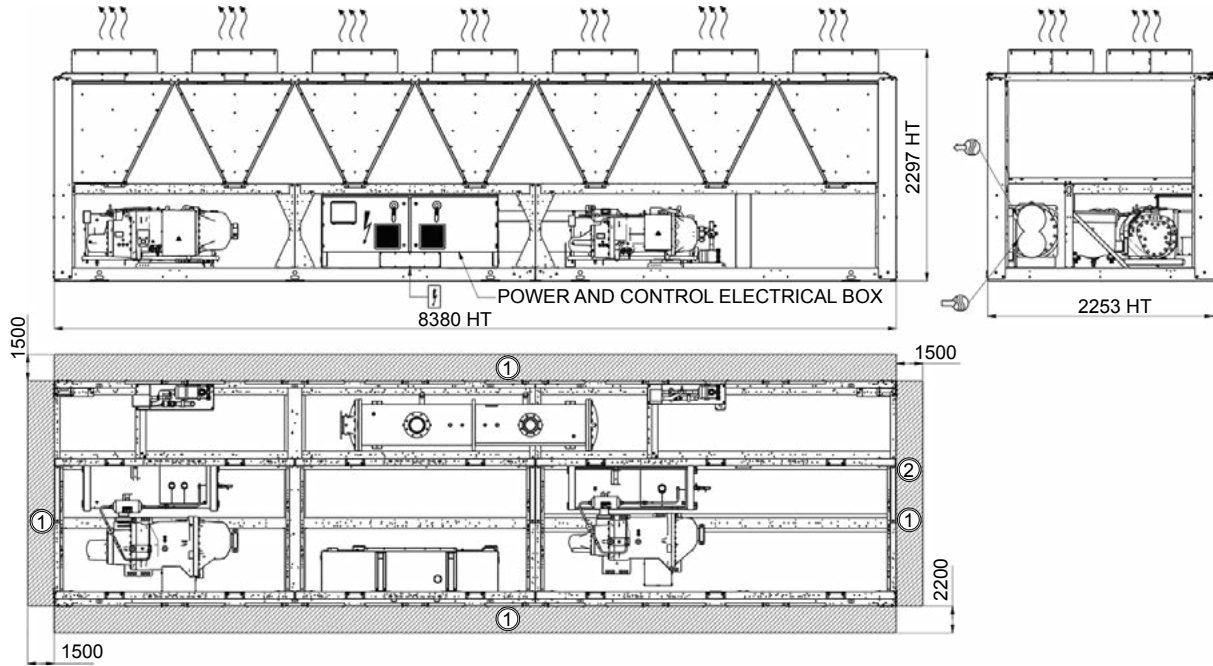



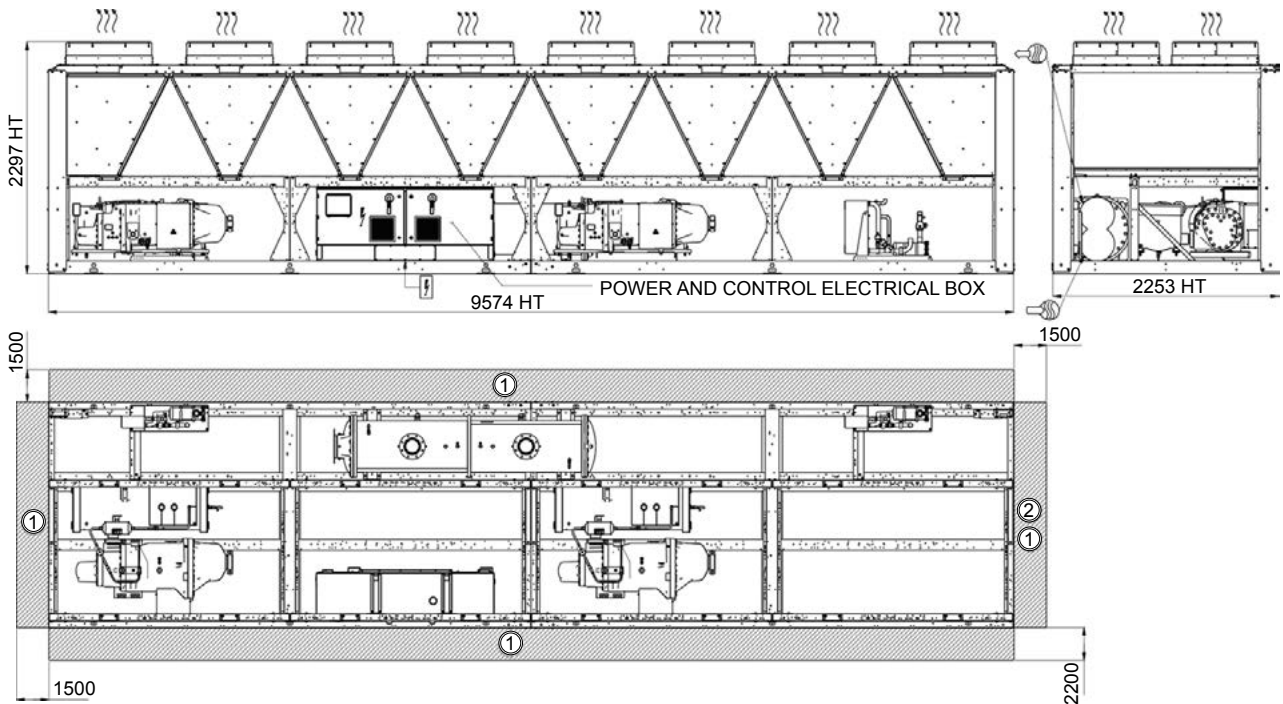

3.6 - 30XBP-1000, 30XB-900 option 254/255, 30XB-1000 with options 50 (heat recovery) & 118 (free cooling)



Legend

All dimensions are given in mm.

- ① Required clearances for maintenance (see note)
- ② Recommended space for evaporator tube removal
-  Water inlet for standard unit
For options 5, 6, 100A, 100C, 107 refer to the certified drawing.
-  Water inlet for standard unit
For options 5, 6, 100A, 100C, 107 refer to the certified drawing.
-  Air outlet – do not obstruct
-  Power supply and control connection

NOTES:

- **Drawings are not contractually binding.**
- **Before designing an installation, consult the certified dimensional drawings, available on request.**
- **For the positioning of the fixing points, weight distribution and centre of gravity coordinates please refer to the dimensional drawings.**
- **If the installation includes several units or if this (these) is (are) close to walls, please refer to chapters 3.12 - "Multiple chiller installation" and 3.13 - "Distance to the wall" of this document to determine the space required.**

3 - DIMENSIONS, CLEARANCES

3.7 - 30XB-1100 to 1400, 30XBP-1100 to 1400

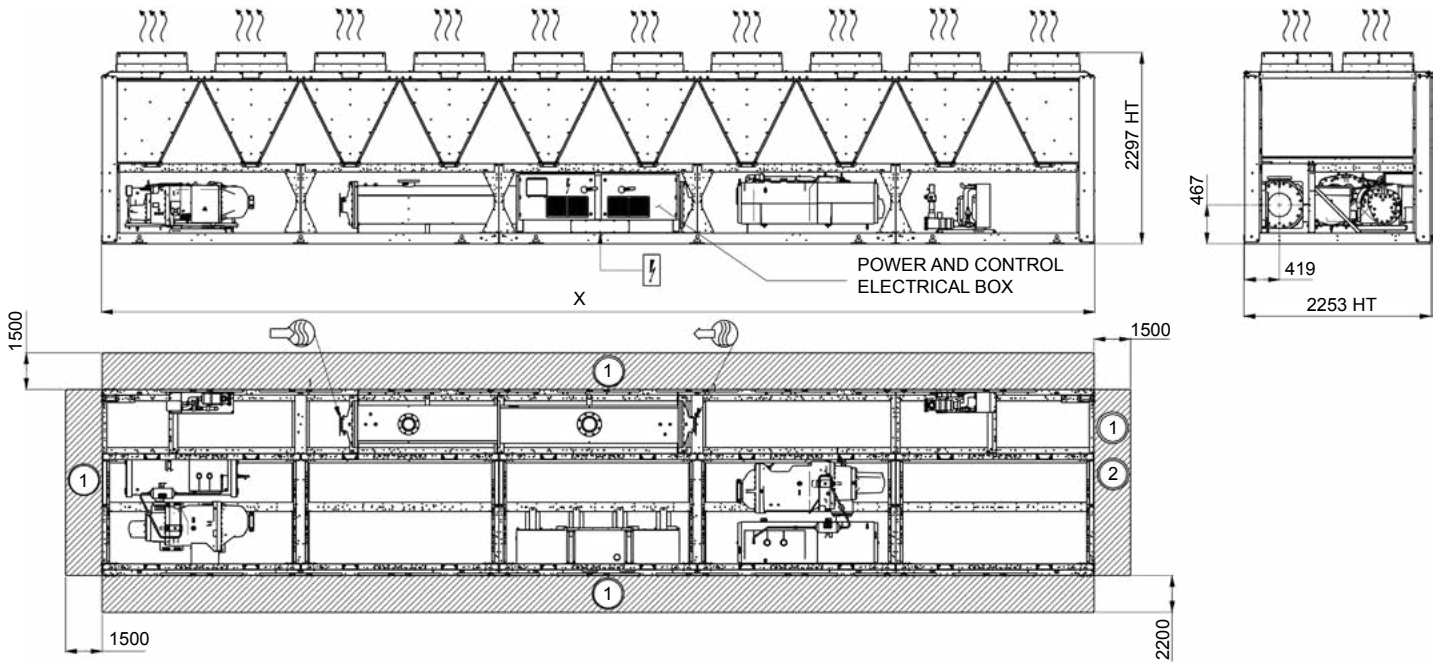

30XB-1100 : X = 9574
 30XB-1200 : X = 10770
 30XB-1300 to 1400, 30XBP-1100 to 1400, 30XB-1100 to 1200 with option 254/255 : X = 11962

3.8 - 30XB-1500, 30XBP-1500

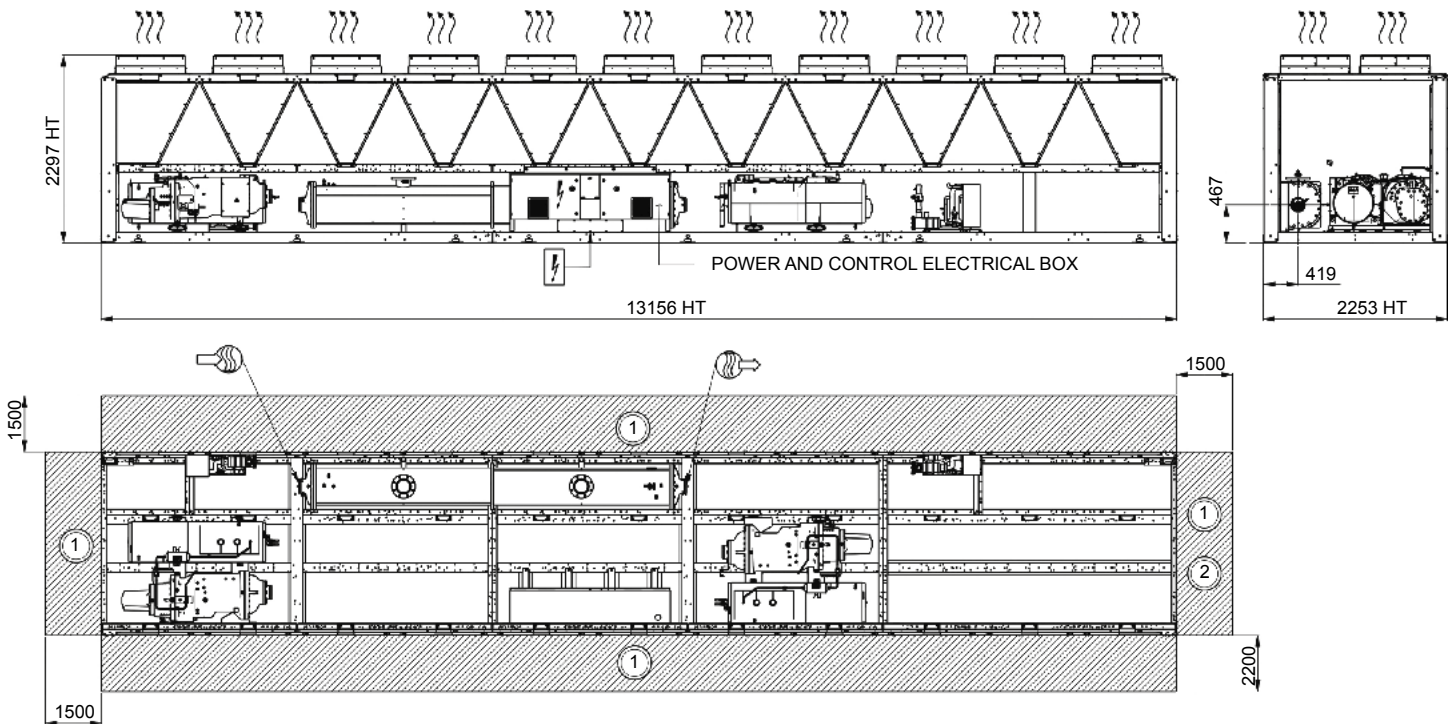

Legend

All dimensions are given in mm.

- ① Required clearances for maintenance (see note)
- ② Recommended space for evaporator tube removal
- Water inlet for standard unit
For options 5, 6, 100A, 100C, 107 refer to the certified drawing.
- Water inlet for standard unit
For options 5, 6, 100A, 100C, 107 refer to the certified drawing.
- Air outlet – do not obstruct
- Power supply and control connection

NOTES:

- **Drawings are not contractually binding.**
- **Before designing an installation, consult the certified dimensional drawings, available on request.**
- **For the positioning of the fixing points, weight distribution and centre of gravity coordinates please refer to the dimensional drawings.**
- **If the installation includes several units or if this (these) is (are) close to walls, please refer to chapters 3.12 - "Multiple chiller installation" and 3.13 - "Distance to the wall" of this document to determine the space required.**

3 - DIMENSIONS, CLEARANCES

3.9 - 30XB-1550 module 1/2

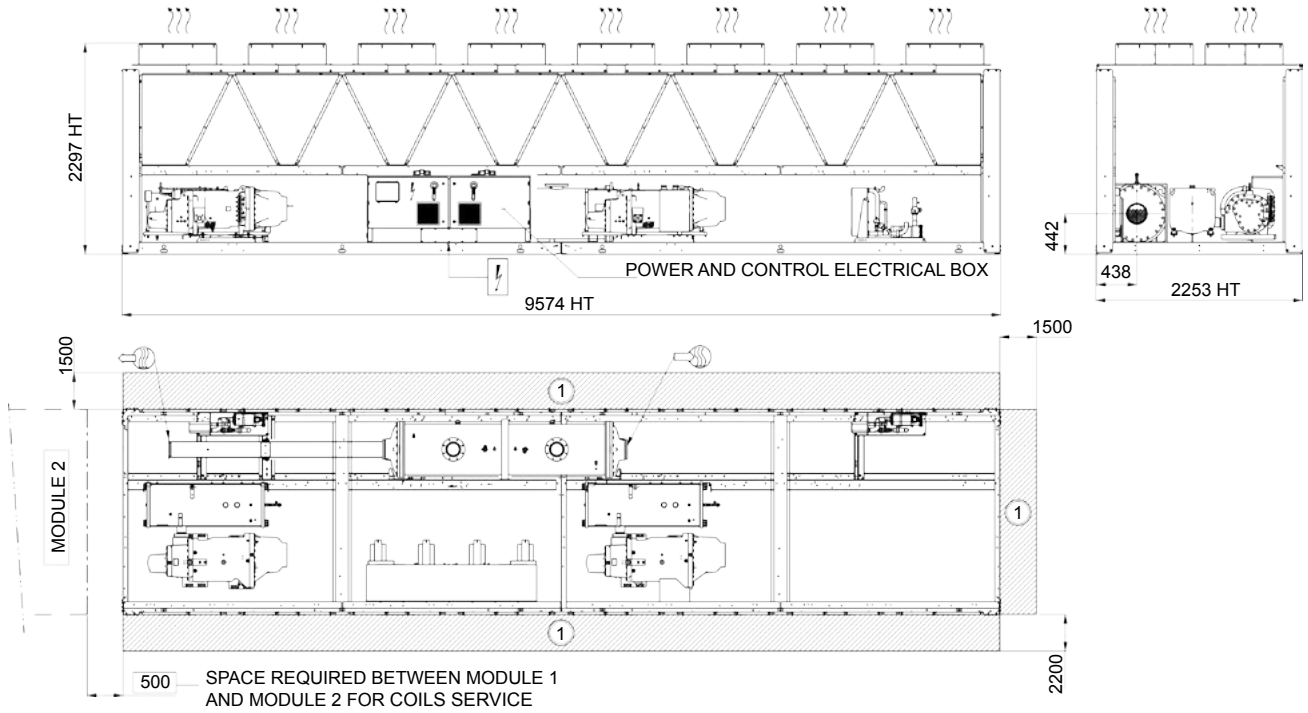



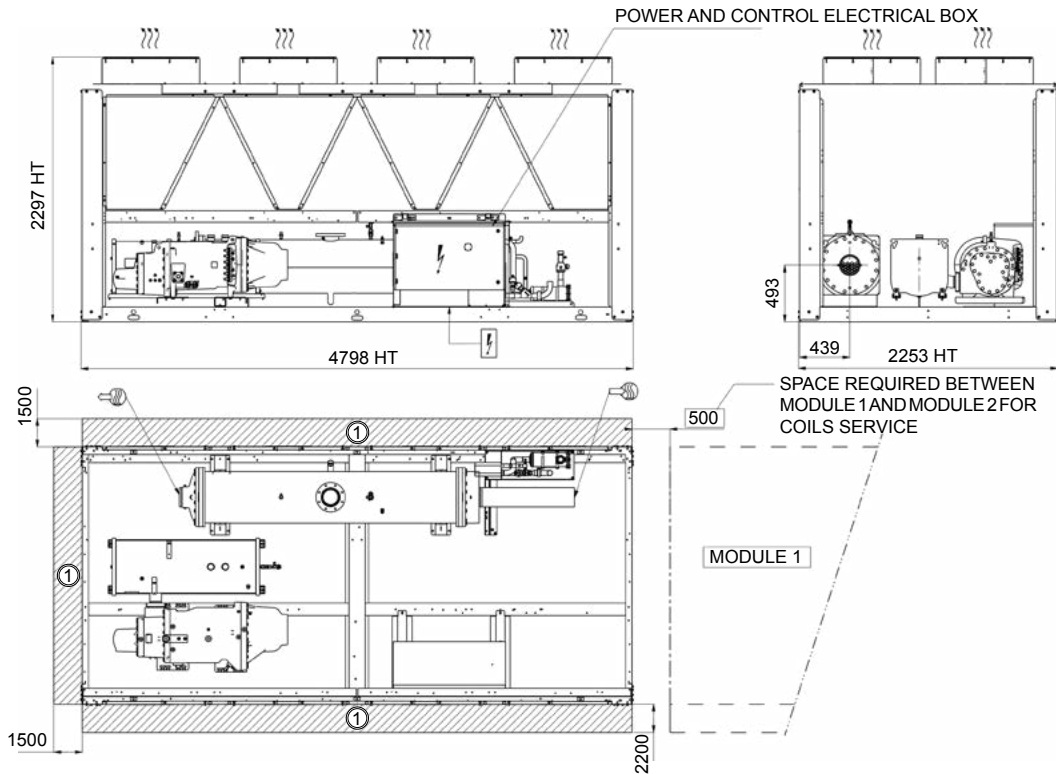

3.10 - 30XB-1550 module 2/2



Legend

All dimensions are given in mm.

- ① Required clearances for maintenance (see note)
- ② Recommended space for evaporator tube removal
-  Water inlet for standard unit
For options 5, 6, 100A, 100C, 107 refer to the certified drawing.
-  Water inlet for standard unit
For options 5, 6, 100A, 100C, 107 refer to the certified drawing.
-  Air outlet – do not obstruct
-  Power supply and control connection

NOTES:

- Drawings are not contractually binding.
- Before designing an installation, consult the certified dimensional drawings, available on request.
- For the positioning of the fixing points, weight distribution and centre of gravity coordinates please refer to the dimensional drawings.
- If the installation includes several units or if this (these) is (are) close to walls, please refer to chapters 3.12 - "Multiple chiller installation" and 3.13 - "Distance to the wall" of this document to determine the space required.

3 - DIMENSIONS, CLEARANCES

3.11 - 30XB-1700 module 1/2

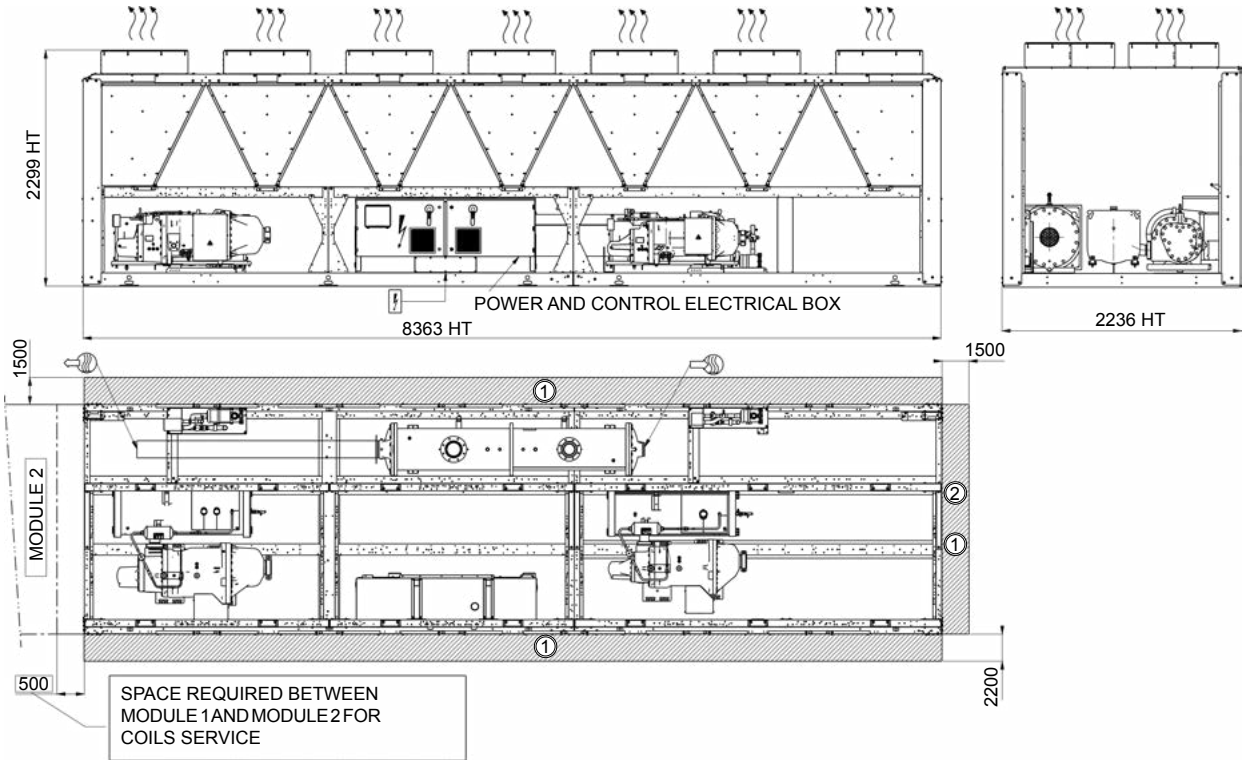



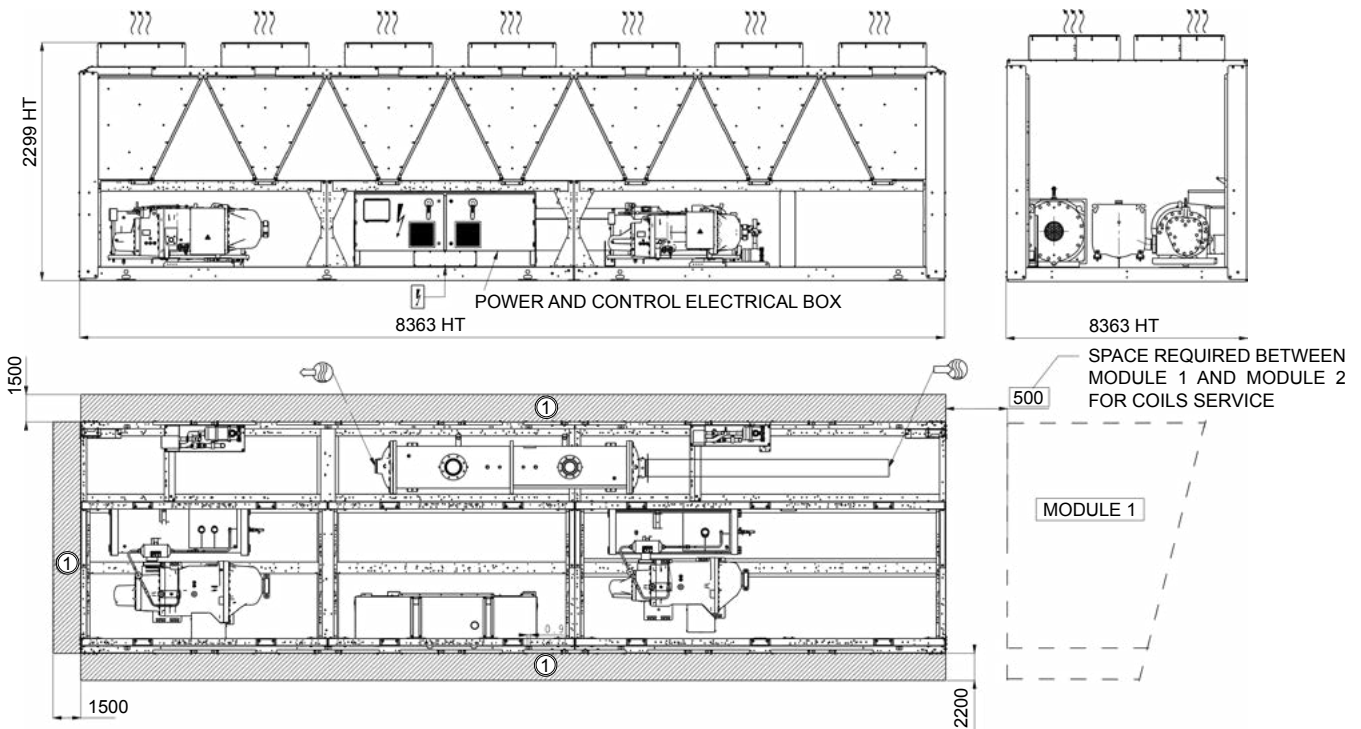

3.12 - 30XB-1700 module 2/2



Legend

All dimensions are given in mm.

- ① Required clearances for maintenance (see note)
- ② Recommended space for evaporator tube removal
-  Water inlet for standard unit
For options 5, 6, 100A, 100C, 107 refer to the certified drawing.
-  Water inlet for standard unit
For options 5, 6, 100A, 100C, 107 refer to the certified drawing.
-  Air outlet – do not obstruct
-  Power supply and control connection

NOTES:

- Drawings are not contractually binding.
- Before designing an installation, consult the certified dimensional drawings, available on request.
- For the positioning of the fixing points, weight distribution and centre of gravity coordinates please refer to the dimensional drawings.
- If the installation includes several units or if this (these) is (are) close to walls, please refer to chapters 3.12 - "Multiple chiller installation" and 3.13 - "Distance to the wall" of this document to determine the space required.

3 - DIMENSIONS, CLEARANCES

3.13 - Multiple chiller installation

It is recommended to install multiple chillers in a single row, arranged as shown in the example below, to avoid recycling of warm air from one unit to another.

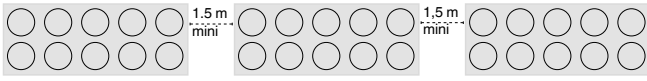

If the situation at the site does not permit this arrangement, contact your Carrier distributor to evaluate the various possible arrangements. In certain situations an accessory (supplied loose at the time of purchase) can be added.

3.14 - Distance to the wall

To ensure correct operation for most cases:

If $h < H$ (2.3 m), minimum $S = 3$ m

If $h > H$ or $S < 3$ m, contact your Carrier distributor to evaluate the various possible arrangements. In certain situations an accessory (supplied loose at the time of purchase) can be added.

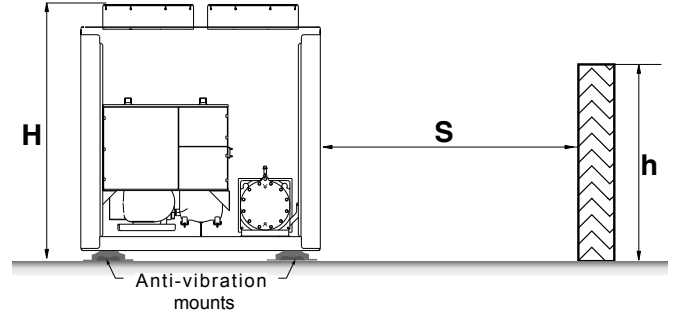

4 - PHYSICAL AND ELECTRICAL DATA FOR 30XB UNITS

4.1 - Physical data 30XB

30XB-250 to 800 standard units

30XB		250	300	350	400	450	500	600	700	750	800
Sound levels											
Standard unit											
Sound power ⁽¹⁾	dB(A)	99	99	99	99	101	99	101	99	103	103
Sound pressure at 10 m ⁽²⁾	dB(A)	67	67	67	67	69	67	68	67	70	70
Unit + option 15⁽³⁾											
Sound power ⁽¹⁾	dB(A)	93	93	94	95	95	95	97	96	97	98
Sound pressure at 10 m ⁽²⁾	dB(A)	61	61	62	63	63	63	65	63	64	65
Unit + option 15LS⁽³⁾											
Sound power ⁽¹⁾	dB(A)	87	87	87	90	91	91	93	92	94	94
Sound pressure at 10 m ⁽²⁾	dB(A)	54	54	54	57	58	58	59	58	60	60
Unit + option 15LS+⁽³⁾											
Sound power ⁽¹⁾	dB(A)	-	-	-	-	89	89	91	90	91	92
Sound pressure at 10 m ⁽²⁾	dB(A)	-	-	-	-	56	56	57	56	58	58
Dimensions											
Standard unit											
Length	mm	3604	3604	3604	4798	4798	4798	7186	7186	7186	7186
Width	mm	2253	2253	2253	2253	2253	2253	2253	2253	2253	2253
Height	mm	2297	2297	2297	2297	2297	2297	2297	2297	2297	2297
Operating weight⁽⁴⁾											
Standard unit											
	kg	3025	3059	3080	3669	3734	3802	4797	4928	5211	5522
Unit + option 15⁽³⁾											
	kg	3293	3327	3348	3968	4033	4101	5128	5259	5542	5853
Unit + option 118A⁽³⁾											
	kg	3109	3143	3164	3773	3838	4186	4929	5060	5358	5669
Unit + option 50⁽³⁾											
	kg	3370	3404	3425	4102	4245	4601	5551	5782	6065	6382
Compressors											
06T semi-hermetic screw compressor, 50 r/s											
Circuit A		1	1	1	1	1	1	1	1	1	1
Circuit B		1	1	1	1	1	1	1	1	1	1
No. of control stages											
Refrigerant for standard unit⁽⁴⁾											
R134a											
Circuit A											
	kg	37	35	35	51	52	54	58	58	65	69
	teqCO ₂	52,9	50,1	50,1	72,2	74,4	76,5	82,9	82,9	93,0	98,7
Circuit B											
	kg	39	36	37	37	37	33	59	62	58	65
	teqCO ₂	55,1	51,5	52,9	52,2	52,9	46,5	84,4	88,7	82,9	93,0
Oil											
Circuit A											
	l	20,8	20,8	20,8	23,5	23,5	23,5	23,5	23,5	27,6	27,6
Circuit B											
	l	20,8	20,8	20,8	20,8	20,8	20,8	23,5	23,5	23,5	23,5

(1) In dB ref=10⁻¹² W, 'A' weighted. Declared dual-number noise emission values in accordance with ISO 4871 with an associated uncertainty of +/-3dB(A). Measured in accordance with ISO 9614-1 and certified by Eurovent.

(2) In dB ref 20µPa, 'A' weighted. Declared dual-number noise emission values in accordance with ISO 4871 with an associated uncertainty of +/-3dB(A). For information, calculated from the sound power Lw(A).

(3) Options : 15 = Low noise, 15LS = Very Low noise, 118a = DX freecooling option, 50= Heat recovery.

(4) Values are guidelines only. Refer to the unit name plate.



Eurovent certified values

4 - PHYSICAL AND ELECTRICAL DATA FOR 30XB UNITS

4.1 - Physical data 30XB (continued)

30XB-250 to 800 standard units (continued)

30XB	250	300	350	400	450	500	600	700	750	800	
Capacity control	Touch Pilot, , Electronic Expansion Valve (EXV)										
Minimum capacity	%	15	15	15	15	15	15	15	15	15	15
Air heat exchanger	Aluminum micro-channel coils (MCHC)										
Fans	FLYING-BIRD 6, axial fan with rotating impeller										
Standard unit											
Quantity		6	6	6	8	8	8	11	12	12	12
Maximum total air flow	l/s	28920	28920	28920	38560	38560	38560	53020	57840	57840	57840
Maximum rotation speed	r/s	15,7	15,7	15,7	15,7	15,7	15,7	15,7	15,7	15,7	15,7
Unit + option 15LS											
Maximum total air flow	l/s	23580	23580	23580	31440	31440	31440	43230	47160	47160	47160
Maximum rotation speed	r/s	11,7	11,7	11,7	11,7	11,7	11,7	11,7	11,7	11,7	11,7
Water heat exchanger	Flooded multi-pipe type										
Water volume	l	58	61	61	66	70	77	79	94	98	119
Max. water-side operating pressure without hydraulic module	kPa	1000	1000	1000	1000	1000	1000	1000	1000	1000	1000
Hydraulic module (option)	Pump, Victaulic screen filter, relief valve, water and air drain valve, pressure sensors, expansion tank (option)										
Pump	Centrifugal pump, monocoil, 48,3r/s, low or high pressure (as required), single or dual (as required)										
Expansion vessel volume	l	50	50	50	50	50	80				
Max. water-side operating pressure with hydraulic module	kPa	400	400	400	400	400	400				
Water connections without or with hydraulic module	Victaulic® type										
Connections	inch	5 or 4	5 or 4	5 or 4	5 or 4	5 or 4	5 or 4	5	6	6	6
External parameter ⁽⁵⁾	mm	114,3 or 141,3	114,3 or 141,3	114,3 or 141,3	114,3 or 141,3	114,3 or 141,3	114,3 or 141,3	141,3	168,3	168,3	168,3
Casing paint	Colour code RAL 7035										

(5) Depends on options.

4 - PHYSICAL AND ELECTRICAL DATA FOR 30XB UNITS

4.1 - Physical data 30XB (continued)

30XB-850 to 1700 standard units

30XB		850	900	1000	1100	1200	1300	1400	1500	1550	1700
Sound levels											
Standard unit											
Sound power ⁽¹⁾	dB(A)	101	104	102	103	102	104	104	104	104	104
Sound pressure at 10 m ⁽²⁾	dB(A)	70	71	69	70	69	71	71	71	71	70
Unit + option 15⁽³⁾											
Sound power ⁽¹⁾	dB(A)	97	99	98	98	98	100	99	99	100	100
Sound pressure at 10 m ⁽²⁾	dB(A)	65	66	65	65	65	67	65	65	67	66
Unit + option 15LS⁽³⁾											
Sound power ⁽¹⁾	dB(A)	94	95	94	94	94	99	95	96	96	96
Sound pressure at 10 m ⁽²⁾	dB(A)	60	62	65	65	61	65	61	-1	61	61
Unit + option 15LS+⁽³⁾											
Sound power ⁽¹⁾	dB(A)	91	93	92	93	93	97	94	95	93	93
Sound pressure at 10 m ⁽²⁾	dB(A)	58	60	59	60	60	66	61	62	60	60
Dimensions											
Standard unit											
Length	mm	7186	7186	8380	9574	10770	11962	11962	13157	9574/ 4798	8380/ 8380
Width	mm	2253	2253	2253	2253	2253	2253	2253	2253	2253	2253
Height	mm	2297	2297	2297	2297	2297	2297	2297	2297	2297	2297
Operating weight⁽⁴⁾											
Standard unit											
	kg	5570	5848	6318	7292	7755	8625	8702	9016	3422/ 6714	5957/ 5957
Unit + option 15 ⁽³⁾	kg	5901	6179	6649	7663	8126	8997	9074	9388	3588/ 7046	6288/ 6288
Unit + option 118A ⁽³⁾	kg	6004	6302	6771	-	-	-	-	-	-	-
Unit + option 50 ⁽³⁾	kg	6430	6805	7272	-	-	-	-	-	-	-
Compressors											
06T semi-hermetic screw compressor, 50 r/s											
Circuit A		1	1	1	1	1	1	1	1	1	1
Circuit B		1	1	1	1	1	1	1	1	1	1
Circuit C										1	1
Circuit D											1
No. of control stages											
Refrigerant for standard unit⁽⁴⁾											
R134a											
Circuit A	kg	69	67	71	76	76	110	116	132	85	72
	teqCO ₂	98,7	95,8	100,8	108,7	108,7	157,3	165,9	188,8	121,6	103,0
Circuit B	kg	65	67	72	108	120	116	124	120	88	63
	teqCO ₂	93,0	95,8	103,0	154,4	171,6	165,9	177,3	171,6	125,8	90,1
Circuit C	kg									80	72
	teqCO ₂									114,4	103,0
Circuit D	kg										63
											90,1
Oil											
Circuit A	l	27,6	27,6	27,6	27,6	27,6	36,0	36,0	36,0	27,6	27,6
Circuit B	l	23,5	27,6	27,6	36,0	36,0	36,0	36,0	36,0	27,6	23,5
Circuit C	l									27,6	27,6
Circuit D	l										23,5

(1) in dB ref=10-12 W, 'A' weighted. Declared dual-number noise emission values in accordance with ISO 4871 with an associated uncertainty of +/-3dB(A). Measured in accordance with ISO 9614-1 and certified by Eurovent.

(2) In dB ref 20µPa, 'A' weighted. Declared dual-number noise emission values in accordance with ISO 4871 with an associated uncertainty of +/-3dB(A). For information, calculated from the sound power Lw(A).

(3) Options : 15 = Low noise, 15LS = Very Low noise, 118a = DX freecooling option, 50= Heat recovery.

(4) Values are guidelines only. Refer to the unit name plate.



Eurovent certified values

4 - PHYSICAL AND ELECTRICAL DATA FOR 30XB UNITS

4.1 - Physical data 30XB (continued)

30XB-850 to 1700 standard units (continued)

30XB		850	900	1000	1100	1200	1300	1400	1500	1550	1700
Capacity control		Touch Pilot, , Electronic Expansion Valve (EXV)									
Minimum capacity	%	15	15	15	15	15	15	15	15	10	8
Air heat exchanger		Aluminum micro-channel coils (MCHE)									
Fans		FLYING-BIRD 6, axial fan with rotating impeller									
Standard unit											
Quantity		12	12	14	16	18	20	20	22	24	28
Maximum total air flow	l/s	57840	57840	67480	77120	86760	96400	96400	106040	115680	134960
Maximum rotation speed	r/s	15,7	15,7	15,7	15,7	15,7	15,7	15,7	15,7	15,7	15,7
Unit + option 15LS											
Maximum total air flow	l/s	47160	47160	55020	62880	70740	78600	78600	86460	94320	110040
Maximum rotation speed	r/s	11,7	11,7	11,7	11,7	11,7	11,7	11,7	11,7	11,7	11,7
Water heat exchanger		Flooded multi-pipe type									
Water volume	l	119	130	140	164	174	180	189	189	240	240
Max. water-side operating pressure without hydraulic module	kPa	1000	1000	1000	1000	1000	1000	1000	1000	1000	1000
Water connections without or with hydraulic module		Victaulic® type									
Connections	inch	6	6	6	6	6	6	6	6	8/6	6
External parameter ⁽⁵⁾	mm	168,3	168,3	168,3	168,3	168,3	168,3	168,3	168,3	219,1/ 168,3	168,3
Casing paint		Colour code RAL 7035									

(5) Depends of options.

4 - PHYSICAL AND ELECTRICAL DATA FOR 30XB UNITS

4.2 - Physical data 30XBP

30XBP-250 to 800

30XBP		250	300	350	400	450	500	600	700	750	800
Sound levels											
Standard unit											
Sound power ⁽¹⁾	dB(A)	99	99	99	99	101	99	101	99	103	103
Sound pressure at 10 m ⁽²⁾	dB(A)	67	67	67	67	69	67	68	67	70	70
Unit + option 15⁽³⁾											
Sound power ⁽¹⁾	dB(A)	93	93	94	95	95	95	97	96	97	98
Sound pressure at 10 m ⁽²⁾	dB(A)	61	61	62	63	63	63	65	63	64	65
Unit + option 15LS⁽³⁾											
Sound power ⁽¹⁾	dB(A)	87	87	87	90	91	91	93	92	94	94
Sound pressure at 10 m ⁽²⁾	dB(A)	55	55	55	58	59	59	60	59	61	61
Unit + option 15LS+⁽³⁾											
Sound power ⁽¹⁾	dB(A)	-	-	-	-	-	-	-	-	-	-
Sound pressure at 10 m ⁽²⁾	dB(A)	-	-	-	-	-	-	-	-	-	-
Dimensions											
Standard unit											
Length	mm	3604	3604	3604	4798	4798	5992	7186	7186	7186	7186
Width	mm	2253	2253	2253	2253	2253	2253	2253	2253	2253	2253
Height	mm	2297	2297	2297	2297	2297	2297	2297	2297	2297	2297
Operating weight⁽⁴⁾											
Standard unit											
	kg	3190	3224	3245	3834	3899	4261	4962	5093	5376	5687
Unit + option 15⁽³⁾											
	kg	3458	3492	3513	4133	4198	4560	5293	5424	5707	6018
Compressors											
06T semi-hermetic screw compressor, 50 r/s											
Circuit A		1	1	1	1	1	1	1	1	1	1
Circuit B		1	1	1	1	1	1	1	1	1	1
No. of control stages											
Refrigerant for standard unit⁽⁴⁾											
R134a											
Circuit A	kg	37	35	35	51	52	54	58	58	65	69
	teqCO ₂	52,9	50,1	50,1	72,2	74,4	76,5	82,9	82,9	93,0	98,7
Circuit B	kg	38,5	36	37	36,5	37	32,5	59	62	58	65
	teqCO ₂	55,1	51,5	52,9	52,2	52,9	46,5	84,4	88,7	82,9	93,0
Oil											
Circuit A	l	20,8	20,8	20,8	23,5	23,5	23,5	23,5	23,5	27,6	27,6
Circuit B	l	20,8	20,8	20,8	20,8	20,8	20,8	23,5	23,5	23,5	23,5

(1) In dB ref=10-12 W, 'A' weighted. Declared dual-number noise emission values in accordance with ISO 4871 with an associated uncertainty of +/-3dB(A). Measured in accordance with ISO 9614-1 and certified by Eurovent.

(2) In dB ref 20µPa, 'A' weighted. Declared dual-number noise emission values in accordance with ISO 4871 with an associated uncertainty of +/-3dB(A). For information, calculated from the sound power Lw(A).

(3) Options : 15 = Low noise, 15LS = Very Low noise, 118a = DX freecooling option, 50= Heat recovery.

(4) Values are guidelines only. Refer to the unit name plate.



Eurovent certified values

4 - PHYSICAL AND ELECTRICAL DATA FOR 30XB UNITS

4.1 - Physical data 30XBP (continued)

30XBP-250 to 800 (continued)

30XBP		250	300	350	400	450	500	600	700	750	800
Capacity control		Touch Pilot, , Electronic Expansion Valve (EXV)									
Minimum capacity	%	15	15	15	15	15	15	15	15	15	15
Air heat exchanger		Aluminum micro-channel coils (MCHC)									
Fans		FLYING-BIRD 6, axial fan with rotating impeller									
Standard unit											
Quantity		6	6	6	8	8	9	11	12	12	12
Maximum total air flow	l/s	28920	28920	28920	38560	38560	43380	53020	57840	57840	57840
Maximum rotation speed	r/s	15,7	15,7	15,7	15,7	15,7	15,7	15,7	15,7	15,7	15,7
Unit + option 15LS											
Maximum total air flow	l/s	23580	23580	23580	31440	31440	35370	43230	47160	47160	47160
Maximum rotation speed	r/s	11,7	11,7	11,7	11,7	11,7	11,7	11,7	11,7	11,7	11,7
Water heat exchanger		Flooded multi-pipe type									
Water volume	l	58	61	61	66	70	77	79	94	98	119
Max. water-side operating pressure without hydraulic module	kPa	1000	1000	1000	1000	1000	1000	1000	1000	1000	1000
Hydraulic module (option)		Pump, Victaulic screen filter, relief valve, water and air drain valve, pressure sensors, expansion tank (option)									
Pump		Centrifugal pump, monocell, 48,3r/s, low or high pressure (as required), single or dual (as required)									
Expansion vessel volume	inch	50	50	50	50	50	80				
Max. water-side operating pressure with hydraulic module	mm	400	400	400	400	400	400				
Water connections without or with hydraulic module		Victaulic® type									
Connections	inch	5 or 4	5 or 4	5 or 4	5 or 4	5 or 4	5 or 4	5	6	6	6
External parameter ⁽⁵⁾	mm	114,3 or 141,3	114,3 or 141,3	114,3 or 141,3	114,3 or 141,3	114,3 or 141,3	114,3 or 141,3	141,3	168,3	168,3	168,3
Casing paint		Colour code RAL 7035									

(5) Depends of options.

4 - PHYSICAL AND ELECTRICAL DATA FOR 30XB UNITS

4.1 - Physical data 30XBP (continued)

30XBP-850 to 1500

30XBP		850	900	1000	1100	1200	1300	1400	1500
Sound levels									
Standard unit									
Sound power ⁽¹⁾	dB(A)	101	104	102	103	102	104	104	104
Sound pressure at 10 m ⁽²⁾	dB(A)	70	71	69	70	69	71	71	71
Unit + option 15⁽³⁾									
Sound power ⁽¹⁾	dB(A)	97	99	98	98	98	100	99	99
Sound pressure at 10 m ⁽²⁾	dB(A)	65	66	65	65	65	67	65	65
Unit + option 15LS⁽³⁾									
Sound power ⁽¹⁾	dB(A)	94	95	94	94	94	99	95	96
Sound pressure at 10 m ⁽²⁾	dB(A)	61	62	61	61	61	66	62	63
Unit + option 15LS+⁽³⁾									
Sound power ⁽¹⁾	dB(A)	-	-	-	-	-	-	-	-
Sound pressure at 10 m ⁽²⁾	dB(A)	-	-	-	-	-	-	-	-
Dimensions									
Standard unit									
Length	mm	8380	8380	9574	11962	11962	11962	11962	13157
Width	mm	2253	2253	2253	2253	2253	2253	2253	2253
Height	mm	2297	2297	2297	2297	2297	2297	2297	2297
Operating weight⁽⁴⁾									
Standard unit									
Unit + option 15 ⁽³⁾	kg	6072	6376	6827	8070	8211	8790	8867	9181
Unit + option 15 ⁽³⁾	kg	6403	6707	7158	8441	8582	9162	9239	9553
Compressors									
06T semi-hermetic screw compressor, 50 r/s									
Circuit A		1	1	1	1	1	1	1	1
Circuit B		1	1	1	1	1	1	1	1
No. of control stages									
Refrigerant for standard unit⁽⁴⁾									
R134a									
Circuit A	kg	72	69	75	76	76	110	116	132
	teqCO ₂	103,0	98,7	107,3	108,7	108,7	157,3	165,9	188,8
Circuit B	kg	63	76	79	108	120	116	124	120
	teqCO ₂	90,1	108,7	113,0	154,4	171,6	165,9	177,3	171,6
Oil									
Circuit A	l	27,6	27,6	27,6	27,6	27,6	36,0	36,0	36,0
Circuit B	l	23,5	27,6	27,6	36,0	36,0	36,0	36,0	36,0

(1) In dB ref=10⁻¹² W, 'A' weighted. Declared dual-number noise emission values in accordance with ISO 4871 with an associated uncertainty of +/-3dB(A). Measured in accordance with ISO 9614-1 and certified by Eurovent.

(2) In dB ref 20µPa, 'A' weighted. Declared dual-number noise emission values in accordance with ISO 4871 with an associated uncertainty of +/-3dB(A). For information, calculated from the sound power Lw(A).

(3) Options : 15 = Low noise, 15LS = Very Low noise, 118a = DX freecooling option, 50= Heat recovery.

(4) Values are guidelines only. Refer to the unit name plate.



Eurovent certified values

4 - PHYSICAL AND ELECTRICAL DATA FOR 30XB UNITS

4.1 - Physical data 30XBP (continued)

30XBP-850 to 1500 (continued)

30XBP		850	900	1000	1100	1200	1300	1400	1500
Capacity control		Touch Pilot, , Electronic Expansion Valve (EXV)							
Minimum capacity	%	15	15	15	15	15	15	15	15
Air heat exchanger		Aluminum micro-channel coils (MCHE)							
Fans		FLYING-BIRD 6, axial fan with rotating impeller							
Standard unit									
Quantity		14	14	16	20	20	20	20	22
Maximum total air flow	l/s	67480	67480	77120	96400	96400	96400	96400	106040
Maximum rotation speed	r/s	15,7	15,7	15,7	15,7	15,7	15,7	15,7	15,7
Unit + option 15LS									
Maximum total air flow	l/s	55020	55020	62880	78600	78600	78600	78600	86460
Maximum rotation speed	r/s	11,7	11,7	11,7	11,7	11,7	11,7	11,7	11,7
Water heat exchanger		Flooded multi-pipe type							
Water volume	l	119	130	140	164	174	180	189	189
Max. water-side operating pressure without hydraulic module	kPa	1000	1000	1000	1000	1000	1000	1000	1000
Hydraulic module (option)		Pump, Victaulic screen filter, relief valve, water and air drain valve, pressure sensors, expansion tank (option)							
Pump		Centrifugal pump, monocell, 48,3r/s, low or high pressure (as required), single or dual (as required)							
Expansion vessel volume	inch								
Max. water-side operating pressure with hydraulic module	mm								
Water connections without or with hydraulic module		Victaulic® type							
Connections	inch	6	6	8	6	6	6	6	6
External parameter ⁽⁵⁾	mm	168,3	168,3	219,1	168,3	168,3	168,3	168,3	168,3
Casing paint		Colour code RAL 7035							

(5) Depends of options.

4 - PHYSICAL AND ELECTRICAL DATA FOR 30XB UNITS

4.3 - Physical data 30XB with option 254 or 255

30XB-250 to 800 with option 254 or 255

30XB option 254/255		250	300	350	400	450	500	600	700	750	800
Sound levels											
Standard unit											
Sound power ⁽¹⁾	dB(A)	99	99	99	99	101	99	101	99	103	103
Sound pressure at 10 m ⁽²⁾	dB(A)	67	67	67	67	69	67	68	67	70	70
Unit + option 15⁽³⁾											
Sound power ⁽¹⁾	dB(A)	93	93	94	95	95	95	97	96	97	98
Sound pressure at 10 m ⁽²⁾	dB(A)	61	61	62	63	63	63	65	63	64	65
Unit + option 15LS⁽³⁾											
Sound power ⁽¹⁾	dB(A)	87	87	87	90	91	91	93	92	94	94
Sound pressure at 10 m ⁽²⁾	dB(A)	54	54	54	57	58	58	59	58	60	60
Unit + option 15LS+⁽³⁾											
Sound power ⁽¹⁾	dB(A)	-	-	-	-	89	89	91	90	91	92
Sound pressure at 10 m ⁽²⁾	dB(A)	-	-	-	-	56	56	57	56	58	58
Dimensions											
Standard unit											
Length	mm	3604	3604	4798	4798	4798	5992	7186	7186	8380	8380
Width	mm	2253	2253	2253	2253	2253	2253	2253	2253	2253	2253
Height	mm	2297	2297	2297	2297	2297	2297	2297	2297	2297	2297
Operating weight⁽⁴⁾											
Standard unit											
kg		3253	3295	3685	3962	4025	4477	5247	5361	6055	6344
Unit + option 15⁽³⁾											
kg		3521	3563	3953	4261	4324	4776	5578	5692	6386	6675
Compressors											
06T semi-hermetic screw compressor, 50 r/s											
Circuit A		1	1	1	1	1	1	1	1	1	1
Circuit B		1	1	1	1	1	1	1	1	1	1
No. of control stages											
Refrigerant for standard unit ⁽⁴⁾											
R134a											
Circuit A	kg	60	64	70	85	85	102	102	100	129	112
	teqCO ₂	85,8	91,5	100,1	121,6	121,6	145,9	145,9	143,0	184,5	160,2
Circuit B	kg	64	64	56	56	56	56	88	95	88	95
	teqCO ₂	91,5	91,5	80,1	80,1	80,1	80,1	125,8	135,9	125,8	135,9
Oil											
Circuit A	l	20,8	20,8	20,8	23,5	23,5	23,5	23,5	23,5	27,6	27,6
Circuit B	l	20,8	20,8	20,8	20,8	20,8	20,8	23,5	23,5	23,5	23,5

(1) in dB ref=10⁻¹² W, 'A' weighted. Declared dual-number noise emission values in accordance with ISO 4871 with an associated uncertainty of +/-3dB(A). Measured in accordance with ISO 9614-1 and certified by Eurovent.

(2) In dB ref 20µPa, 'A' weighted. Declared dual-number noise emission values in accordance with ISO 4871 with an associated uncertainty of +/-3dB(A). For information, calculated from the sound power Lw(A).

(3) Options : 15 = Low noise, 15LS = Very Low noise, 118a = DX freecooling option, 50= Heat recovery.

(4) Values are guidelines only. Refer to the unit name plate.



Eurovent certified values

4 - PHYSICAL AND ELECTRICAL DATA FOR 30XB UNITS

4.3 - Physical data 30XB with option 254 or 255 (continued)

30XB-250 to 800 with option 254 or 255 (continued)

30XB option 254/255	250	300	350	400	450	500	600	700	750	800	
Capacity control	Touch Pilot, , Electronic Expansion Valve (EXV)										
Minimum capacity	%	15	15	15	15	15	15	15	15	15	15
Air heat exchanger	Aluminum micro-channel coils (MCHC)										
Fans	FLYING-BIRD 6, axial fan with rotating impeller										
Standard unit											
Quantity		6	6	7	8	8	9	11	12	13	13
Maximum total air flow	l/s	28920	28920	33740	38560	38560	43380	53020	57840	62660	62660
Maximum rotation speed	r/s	15,7	15,7	15,7	15,7	15,7	15,7	15,7	15,7	15,7	15,7
Unit + option 15LS											
Maximum total air flow	l/s	23580	23580	27510	31440	31440	35370	43230	47160	51090	51090
Maximum rotation speed	r/s	11,7	11,7	11,7	11,7	11,7	11,7	11,7	11,7	11,7	11,7
Water heat exchanger	Flooded multi-pipe type										
Water volume	l	58	61	61	66	70	77	79	94	98	119
Max. water-side operating pressure without hydraulic module	kPa	1000	1000	1000	1000	1000	1000	1000	1000	1000	1000
Hydraulic module (option)	Pump, Victaulic screen filter, relief valve, water and air drain valve, pressure sensors, expansion tank (option)										
Pump	Centrifugal pump, monocell, 48,3r/s, low or high pressure (as required), single or dual (as required)										
Expansion vessel volume	inch	50	50	50	50	50	80				
Max. water-side operating pressure with hydraulic module	mm	400	400	400	400	400	400				
Water connections without or with hydraulic module	Victaulic® type										
Connections	inch	5 or 4	5 or 4	5 or 4	5 or 4	5 or 4	5 or 4	5	6	6	6
External parameter ⁽⁵⁾	mm	114,3 or 141,3	114,3 or 141,3	114,3 or 141,3	114,3 or 141,3	114,3 or 141,3	114,3 or 141,3	141,3	168,3	168,3	168,3
Casing paint	Colour code RAL 7035										

(5) Depends of options.

4 - PHYSICAL AND ELECTRICAL DATA FOR 30XB UNITS

4.3 - Physical data 30XB with option 254 or 255 (continued)

30XB-850 to 1700 with option 254 or 255

30XB option 254/255		850	900	1000	1100	1200	1300	1400	1550	1700
Sound levels										
Standard unit										
Sound power ⁽¹⁾	dB(A)	101	104	102	103	102	104	104	104	104
Sound pressure at 10 m ⁽²⁾	dB(A)	70	71	69	70	69	71	71	71	70
Unit + option 15⁽³⁾										
Sound power ⁽¹⁾	dB(A)	97	99	98	98	98	100	99	100	100
Sound pressure at 10 m ⁽²⁾	dB(A)	65	66	65	65	65	67	65	67	66
Unit + option 15LS⁽³⁾										
Sound power ⁽¹⁾	dB(A)	94	95	94	94	94	99	95	96	96
Sound pressure at 10 m ⁽²⁾	dB(A)	60	62	65	65	61	65	61	61	61
Unit + option 15LS+⁽³⁾										
Sound power ⁽¹⁾	dB(A)	91	93	92	93	93	97	94	93	93
Sound pressure at 10 m ⁽²⁾	dB(A)	58	60	59	60	60	66	61	60	60
Dimensions										
Standard unit										
Length	mm	8380	9574	9574	11962	11962	11962	11962	9574/ 4798	8380/ 8380
Width	mm	2253	2253	2253	2253	2253	2253	2253	2253	2253
Height	mm	2297	2297	2297	2297	2297	2297	2297	2297	2297
Operating weight⁽⁴⁾										
Standard unit										
	kg	6414	7049	7253	8628	8761	9339	9416	3716/ 7287	6464/ 6464
Unit + option 15 ⁽³⁾										
	kg	6745	7380	7584	8999	9132	9711	9788	3882/ 7618	6794/ 6794
Compressors										
06T semi-hermetic screw compressor, 50 r/s										
Circuit A		1	1	1	1	1	1	1	1	1
Circuit B		1	1	1	1	1	1	1	1	1
Circuit C									1	1
Circuit D										1
No. of control stages										
Refrigerant for standard unit⁽⁴⁾										
R134a										
Circuit A	kg	130	129	140	125	128	170	176	140	130
	teqCO ₂	185,9	184,5	200,2	178,8	183,0	243,1	251,7	200,2	185,9
Circuit C	kg	95	103	129	180	196	176	184	129	95
	teqCO ₂	135,9	147,3	184,5	257,4	280,3	251,7	263,1	184,5	135,9
Circuit B	kg								135,0	130,0
	teqCO ₂								193,1	185,9
Circuit D	kg									95,0
	teqCO ₂									135,9
Oil										
Circuit A	l	27,6	27,6	27,6	27,6	36,0	36,0	36,0	27,6	27,6
Circuit B	l	23,5	27,6	27,6	36,0	36,0	36,0	36,0	27,6	23,5
Circuit C	l								27,6	27,6
Circuit D	l									23,5

(1) in dB ref=10⁻¹² W, 'A' weighted. Declared dual-number noise emission values in accordance with ISO 4871 with an associated uncertainty of +/-3dB(A). Measured in accordance with ISO 9614-1 and certified by Eurovent.

(2) In dB ref 20µPa, 'A' weighted. Declared dual-number noise emission values in accordance with ISO 4871 with an associated uncertainty of +/-3dB(A). For information, calculated from the sound power Lw(A).

(3) Options : 15 = Low noise, 15LS = Very Low noise, 118a = DX freecooling option, 50= Heat recovery.

(4) Values are guidelines only. Refer to the unit name plate.



Eurovent certified values

4 - PHYSICAL AND ELECTRICAL DATA FOR 30XB UNITS

4.3 - Physical data 30XB with option 254 or 255 (continued)

30XB-850 to 1700 with option 254 or 255 (continued)

30XB option 254/255	850	900	1000	1100	1200	1300	1400	1550	1700
Capacity control	Touch Pilot, , Electronic Expansion Valve (EXV)								
Minimum capacity %	15	15	15	15	15	15	15	10	8
Air heat exchanger	Aluminum micro-channel coils (MCHE)								
Fans	FLYING-BIRD 6, axial fan with rotating impeller								
Standard unit									
Quantity	14	15	16	19	20	20	20	24	28
Maximum total air flow	l/s	67480	72300	77120	91580	96400	96400	115680	134960
Maximum rotation speed	r/s	15,7	15,7	15,7	15,7	15,7	15,7	15,7	15,7
Unit + option 15LS									
Maximum total air flow	l/s	55020	58950	62880	74670	78600	78600	94320	110040
Maximum rotation speed	r/s	11,7	11,7	11,7	11,7	11,7	11,7	11,7	11,7
Water heat exchanger	Flooded multi-pipe type								
Water volume	l	119	130	140	164	174	180	189	240
Max. water-side operating pressure without hydraulic module	kPa	1000	1000	1000	1000	1000	1000	1000	1000
Water connections without or with hydraulic module	Victaulic® type								
Connections	inch	6	6	8	6	6	6	8/6	6
External parameter ⁽⁵⁾	mm	168,3	168,3	219,1	168,3	168,3	168,3	219,1/ 168,3	168,3
Casing paint	Colour code RAL 7035								

(5) Depends of options.

4.4 - Short-circuit stability current for all units

30XB/30XBP		250 to 500	600 to 1000	1100 to 1500	1550	1700
Short-circuit withstand current (TN system)						
Circuit A+B	kA	38	50	50	50	50
Circuit C+D	kA	NA	NA	50	50	50
Unit + option 81	kA	NA	NA	50	50	NA

(1) If another current limitation protection device is used, its time-current and thermal constraint (I²t) trip characteristics must be at least equivalent to those of the recommended protection.

Note: The short-circuit stability current values above are suitable with the TN system.

4 - PHYSICAL AND ELECTRICAL DATA FOR 30XB UNITS

4.5 - Electrical data

30XB & 30XBP from 250 to 1000

30XB 30XBP		250	300	350	400	450	500	600	700	750	800	850	900	1000
Power circuit supply														
Nominal voltage	V-ph-Hz	400-3-50												
Voltage range	V	360-440												
Control circuit supply														
24 V via internal transformer														
Maximum operating input power⁽¹⁾ - 30XB														
Standard unit	kW	119	133	147	168	195	214	264	285	319	338	367	392	454
Unit + option 15LS	kW	112	126	140	159	185	204	251	271	305	324	353	378	437
Maximum operating input power⁽¹⁾ - 30XBP														
Standard unit	kW	117	131	145	165	192	211	259	279	314	333	362	386	447
Unit + option 15LS	kW	114	127	141	160	187	206	252	272	306	325	354	379	438
Power factor at maximum power⁽¹⁾ - 30XB														
Standard unit														
Displacement Power Factor (Cos Phi)		0,88	0,88	0,88	0,88	0,89	0,89	0,89	0,89	0,89	0,89	0,89	0,90	0,90
Unit + option 15LS														
Displacement Power Factor (Cos Phi)		0,88	0,88	0,88	0,88	0,89	0,89	0,89	0,89	0,89	0,89	0,89	0,90	0,90
Power factor at maximum power⁽¹⁾ - 30XBP														
Standard unit														
Displacement Power Factor (Cos Phi)		0,88	0,88	0,88	0,88	0,89	0,89	0,89	0,89	0,89	0,89	0,89	0,90	0,90
Unit + option 15LS														
Displacement Power Factor (Cos Phi)		0,88	0,88	0,88	0,88	0,89	0,89	0,89	0,89	0,89	0,89	0,89	0,90	0,90
Nominal operating current draw⁽²⁾ - 30XB														
Standard unit	A	151	167	182	210	239	267	324	349	402	430	446	511	541
Unit + option 15LS	A	141	157	172	197	226	254	306	330	383	411	427	492	519
Nominal operating current draw⁽²⁾ - 30XBP														
Standard unit	A	145	161	176	202	231	259	313	337	390	418	434	499	527
Unit + option 15LS	A	139	155	170	194	223	251	302	325	378	406	422	487	513
Maximum operating current draw (Un)⁽¹⁾ - 30XB														
Standard unit	A	198	220	242	278	319	349	430	464	519	549	595	634	734
Unit + option 15LS	A	188	210	232	265	306	336	412	445	500	530	576	615	711
Maximum operating current draw (Un)⁽¹⁾ - 30XBP														
Standard unit	A	192	214	236	270	311	341	419	452	507	537	583	622	720
Unit + option 15LS	A	186	208	230	262	303	333	408	440	495	525	571	610	706
Maximum current (Un-10%)⁽¹⁾ - 30XB														
Standard unit	A	198	220	242	278	319	349	430	464	519	549	595	634	734
Unit + option 15LS	A	188	210	232	265	306	336	412	445	500	530	576	615	711
Maximum current (Un-10%)⁽¹⁾ - 30XBP														
Standard unit	A	192	214	236	270	311	341	419	452	507	537	583	622	720
Unit + option 15LS	A	186	208	230	262	303	333	408	440	495	525	571	610	706
Nominal start-up current⁽³⁾ - 30XB														
Standard unit	A	246	246	261	379	479	479	535	561	734	757	760	843	857
Unit + option 15LS	A	245	245	262	378	480	480	536	562	735	759	761	845	865
Unit + option 25C	A	213	224	224	346	442	442	492	492	676	691	691	733	756
Nominal start-up current⁽³⁾ - 30XBP														
Standard unit	A	240	240	255	371	471	471	524	549	722	745	748	831	843
Unit + option 15LS	A	234	234	249	363	463	463	513	537	710	733	736	819	829
Unit + option 25C	A	207	218	218	338	434	434	481	480	664	679	679	721	742
Maximum start-up current(Un)⁽²⁾ - 30XB														
Standard unit	A	274	274	292	407	510	510	583	616	782	812	812	902	951
Unit + option 15LS	A	264	264	282	394	497	497	565	597	763	793	793	883	929
Unit + option 25C	A	213	224	224	346	442	442	492	492	676	691	691	733	756
Maximum start-up current(Un)⁽²⁾ - 30XBP														
Standard unit	A	268	268	286	399	502	502	572	604	770	800	800	890	937
Unit + option 15LS	A	262	262	280	391	494	494	561	592	758	788	788	878	923
Unit + option 25C	A	207	218	218	338	434	434	481	480	664	679	679	721	742

(1) Values obtained at unit continuous maximum operating conditions (data given on the unit nameplate)

(2) Operating current of the smallest compressor(s) + fan current + locked rotor current or reduced start-up current of the largest compressor.

(3) Standardised EUROVENT conditions, water-cooled exchanger water inlet/outlet = 12°C/7°C, outdoor air temperature = 35°C.

4 - PHYSICAL AND ELECTRICAL DATA FOR 30XB UNITS

4.5 - Electrical data (continued)

30XB from 1100 to 1700

30XB		1100	1200	1300	1400	1500	1550	1700
Power circuit supply								
Nominal voltage	V-ph-Hz	400-3-50						
Voltage range	V	360-440						
Control circuit supply								
24 V via internal transformer								
Maximum operating input power⁽¹⁾								
Standard unit								
Circuit 1 ^(a)	kW	196	225	267	286	309	459	366
Circuit 2 ^(a)	kW	286	312	286	307	309	230	366
Option 081	kW	483	537	553	593	619	689	
Unit + option 15LS								
Circuit 1 ^(a)	kW	190	218	258	276	299	451	354
Circuit 2 ^(a)	kW	277	301	276	297	299	222	354
Option 081	kW	467	520	534	574	598	666	
Power factor at maximum power⁽¹⁾								
Standard unit								
Displacement Power Factor (Cos Phi)		0,88	0,88	0,88	0,88	0,88	0,89	0,89
Unit + option 15LS								
Displacement Power Factor (Cos Phi)		0,88	0,88	0,88	0,88	0,88	0,89	0,89
Nominal operating current draw⁽²⁾								
Standard unit								
Circuit 1 ^(a)	A	258	274	341	356	390	543	446
Circuit 2 ^(a)	A	358	392	356	386	390	273	446
Option 081	A	616	666	697	742	780	820	
Unit + option 15LS								
Circuit 1 ^(a)	A	247	263	325	340	372	530	427
Circuit 2 ^(a)	A	344	374	340	370	372	260	427
Option 081	A	590	637	665	710	745	782	
Maximum operating current draw (Un)⁽¹⁾								
Standard unit								
Circuit 1 ^(a)	A	320	366	440	470	509	740	593
Circuit 2 ^(a)	A	466	509	470	505	509	370	593
Option 081	A	788	877	912	977	1020	1113	
Unit + option 15LS								
Circuit 1 ^(a)	A	309	355	424	454	491	727	574
Circuit 2 ^(a)	A	452	491	454	489	491	357	574
Option 081	A	762	848	880	945	985	1074	

(1) Values obtained at unit continuous maximum operating conditions (data given on the unit nameplate)

(2) Operating current of the smallest compressor(s) + fan current + locked rotor current or reduced start-up current of the largest compressor.

(a) When the machines are equipped with two power supplies, circuit 1 supplies the refrigerant circuit A and circuit 2 supplies the refrigerant circuit B or for units 30XB1550 to 1700 units: Circuit 1 supplies circuits A and B, circuit 2 supplies circuits C and D.

4 - PHYSICAL AND ELECTRICAL DATA FOR 30XB UNITS

4.5 - Electrical data (continued)

30XB from 1100 to 1700 (continued)

30XB		1100	1200	1300	1400	1500	1550	1700
Maximum current (Un-10%)⁽¹⁾								
Standard unit								
Circuit 1 ^(a)	A	320	366	440	470	509	740	593
Circuit 2 ^(a)	A	466	509	470	505	509	370	593
Option 081	A	788	877	912	977	1020	1113	
Unit + option 15LS								
Circuit 1 ^(a)	A	309	355	424	454	491	727	574
Circuit 2 ^(a)	A	452	491	454	489	491	357	574
Option 081	A	762	848	880	945	985	1074	
Nominal start-up current⁽³⁾								
Standard unit								
Circuit 1 ^(a)	A	587	587	629	629	629	954	812
Circuit 2 ^(a)	A	629	629	629	629	629	477	812
Option 081	A	940	980	985	1015	1019	1316	
Option 081 & Opt 25c	A	802	820	844	862	862		
Unit + option 15LS								
Circuit 1 ^(a)	A	576	576	613	613	611	941	793
Circuit 2 ^(a)	A	615	611	613	613	611	464	793
Option 081	A	914	951	953	983	984	1290	
Option 081 & Opt 25c	A	776	791	812	830	826		
Maximum start-up current(Un)⁽²⁾								
Standard unit								
Circuit 1 ^(a)	A	587	587	629	629	629	954	812
Circuit 2 ^(a)	A	629	629	629	629	629	477	812
Option 081	A	1046	1095	1095	1130	1134	1431	
Option 081 & Opt 25c		802	820	844	862	862		
Unit + option 15LS								
Circuit 1 ^(a)	A	576	576	613	613	611	941	793
Circuit 2 ^(a)	A	615	611	613	613	611	464	793
Option 081		1020	1066	1063	1098	1099	1393	
Option 081 & Opt 25c	A	776	791	812	830	826		

(1) Values obtained at unit continuous maximum operating conditions (data given on the unit nameplate)

(2) Operating current of the smallest compressor(s) + fan current + locked rotor current or reduced start-up current of the largest compressor.

(3) Standardised EUROVENT conditions, water-cooled exchanger water inlet/outlet = 12°C/7°C, outdoor air temperature = 35°C.

(a) When the machines are equipped with two power supplies, circuit 1 supplies the refrigerant circuit A and circuit 2 supplies the refrigerant circuit B or for units 30XB1550 to 1700 units: Circuit 1 supplies circuits A and B, circuit 2 supplies circuits C and D.

4 - PHYSICAL AND ELECTRICAL DATA FOR 30XB UNITS

4.5 - Electrical data (continued)

30XBP from 1100 to 1500

30XBP		1100	1200	1300	1400	1500
Power circuit supply						
Nominal voltage	V-ph-Hz	400-3-50				
Voltage range	V	360-440				
Control circuit supply						
24 V via internal transformer						
Maximum operating input power⁽¹⁾						
Standard unit						
Circuit 1 ^(a)	kW	154	164	201	211	230
Circuit 2 ^(a)	kW	214	234	210	229	230
Option 081	kW	368	397	411	439	460
Unit + option 15LS						
Circuit 1 ^(a)	kW	145	157	193	200	219
Circuit 2 ^(a)	kW	200	220	199	215	216
Option 081	kW	348	380	397	419	439
Power factor at maximum power⁽¹⁾						
Standard unit						
Displacement Power Factor (Cos Phi)		0,88	0,88	0,88	0,88	0,88
Unit + option 15LS						
Displacement Power Factor (Cos Phi)		0,86	0,87	0,87	0,86	0,86
Nominal operating current draw⁽²⁾						
Standard unit						
Circuit 1 ^(a)	A	251	267	331	346	379
Circuit 2 ^(a)	A	349	381	346	376	379
Option 081	A	600	648	677	722	758
Unit + option 15LS						
Circuit 1 ^(a)	A	244	260	321	336	368
Circuit 2 ^(a)	A	335	363	330	360	361
Option 081	A	584	630	657	702	736
Maximum operating current draw (Un)⁽¹⁾						
Standard unit						
Circuit 1 ^(a)	A	313	359	430	460	498
Circuit 2 ^(a)	A	457	498	460	495	498
Option 081	A	772	859	892	957	998
Unit + option 15LS						
Circuit 1 ^(a)	A	306	352	420	450	487
Circuit 2 ^(a)	A	448	487	450	485	487
Option 081	A	584	630	657	702	736

(1) Values obtained at unit continuous maximum operating conditions (data given on the unit nameplate)

(2) Operating current of the smallest compressor(s) + fan current + locked rotor current or reduced start-up current of the largest compressor.

(a) When the machines are equipped with two power supplies, circuit 1 supplies the refrigerant circuit A and circuit 2 supplies the refrigerant circuit B or for units 30XBP1550 to 1700 units: Circuit 1 supplies circuits A and B, circuit 2 supplies circuits C and D.

4 - PHYSICAL AND ELECTRICAL DATA FOR 30XB UNITS

4.5 - Electrical data (continued)

30XBP from 1100 to 1500 (continued)

30XBP		1100	1200	1300	1400	1500
Maximum current (Un-10%)⁽¹⁾						
Standard unit						
Circuit 1 ^(a)	A	313	359	430	460	498
Circuit 2 ^(a)	A	457	498	460	495	498
Option 081	A	772	859	892	957	998
Unit + option 15LS						
Circuit 1 ^(a)	A	306	352	420	450	487
Circuit 2 ^(a)	A	448	487	450	485	487
Option 081		584	630	657	702	736
Nominal start-up current⁽³⁾						
Standard unit						
Circuit 1 ^(a)	A	580	580	619	619	618
Circuit 2 ^(a)	A	620	618	619	619	618
Option 081	A	923	962	965	995	997
Option 081 & Opt 25c	A	786	801,5	824	841,5	839,5
Unit + option 15LS						
Circuit 1 ^(a)	A	573	573	609	609	607
Circuit 2 ^(a)	A	611	607	609	609	607
Option 081	A	907	944	945	975	975
Option 081 & Opt 25c	A	770	783,5	804	821,5	817,5
Maximum start-up current(Un)⁽²⁾						
Standard unit						
Circuit 1 ^(a)	A	580	580	619	619	618
Circuit 2 ^(a)	A	620	618	619	619	618
Option 081	A	1030	1077	1075	1110	1112
Option 081 & Opt 25c	A	786	801,5	824	841,5	839,5
Unit + option 15LS						
Circuit 1 ^(a)	A	573	573	609	609	607
Circuit 2 ^(a)	A	611	607	609	609	607
Option 081	A	1014	1059	1055	1090	1090
Option 081 & Opt 25c	A	770	783,5	804	821,5	817,5

(1) Values obtained at unit continuous maximum operating conditions (data given on the unit nameplate)

(2) Operating current of the smallest compressor(s) + fan current + locked rotor current or reduced start-up current of the largest compressor.

(3) Standardised EUROVENT conditions, water-cooled exchanger water inlet/outlet = 12°C/7°C, outdoor air temperature = 35°C.

(a) When the machines are equipped with two power supplies, circuit 1 supplies the refrigerant circuit A and circuit 2 supplies the refrigerant circuit B or for units 30XBP1550 to 1700 units: Circuit 1 supplies circuits A and B, circuit 2 supplies circuits C and D.

4 - PHYSICAL AND ELECTRICAL DATA FOR 30XB UNITS

4.5 - Electrical data (continued)

30XB from 250 to 1000 with option 254 or 255

30XB with option 254 or 255		250	300	350	400	450	500	600	700	750	800	850	900	1000
Power circuit supply														
Nominal voltage	V-ph-Hz	400-3-50												
Voltage range	V	360-440												
Control circuit supply														
24 V via internal transformer														
Maximum operating input power⁽¹⁾														
Standard unit	kW	119	133	149	168	195	216	264	285	321	340	371	398	460
Unit + option 15LS	kW	112	126	141	159	185	205	251	271	306	325	355	381	438
Power factor at maximum power⁽¹⁾														
Standard unit														
Displacement Power Factor (Cos Phi)		0,88	0,88	0,88	0,88	0,89	0,89	0,89	0,89	0,89	0,89	0,89	0,90	0,90
Unit + option 15LS														
Displacement Power Factor (Cos Phi)		0,88	0,88	0,88	0,88	0,89	0,89	0,89	0,89	0,89	0,89	0,89	0,90	0,90
Nominal operating current draw⁽²⁾														
Standard unit	A	151	167	185	210	239	270	324	349	405	433	452	520	550
Unit + option 15LS	A	141	157	174	197	226	256	306	330	385	413	431	498	525
Maximum operating current draw (Un)⁽¹⁾														
Standard unit	A	198	220	245	278	319	352	430	464	522	552	601	643	743
Unit + option 15LS	A	188	210	234	265	306	338	412	445	502	532	580	621	717
Maximum current (Un-10%)⁽¹⁾														
Standard unit	A	198	220	245	278	319	352	430	464	522	552	601	643	743
Unit + option 15LS	A	188	210	234	265	306	338	412	445	502	532	580	621	717
Nominal start-up current⁽³⁾														
Standard unit	A	246	246	264	379	479	482	535	561	737	760	766	852	866
Unit + option 15LS	A	245	245	263	378	480	481	536	562	738	761	765	851	871
Unit + option 25C	A	213	224	224	346	442	442	492	492	676	691	691	733	756
Maximum start-up current(Un)⁽²⁾														
Standard unit	A	274	274	295	407	510	513	583	616	785	815	818	911	960
Unit + option 15LS	A	264	264	284	394	497	499	565	597	765	795	797	889	935
Unit + option 25C	A	213	224	224	346	442	442	492	492	676	691	691	733	756

(1) Values obtained at unit continuous maximum operating conditions (data given on the unit nameplate)

(2) Operating current of the smallest compressor(s) + fan current + locked rotor current or reduced start-up current of the largest compressor.

(3) Standardised EUROVENT conditions, water-cooled exchanger water inlet/outlet = 12°C/7°C, outdoor air temperature = 35°C.

4 - PHYSICAL AND ELECTRICAL DATA FOR 30XB UNITS

4.5 - Electrical data (continued)

30XB from 1100 to 1700 with option 254 or 255

30XB with option 254 or 255		1100	1200	1300	1400	1500	1550	1700
Power circuit supply								
Nominal voltage	V-ph-Hz	400-3-50						
Voltage range	V	360-440						
Control circuit supply								
24 V via internal transformer								
Maximum operating input power⁽¹⁾								
Standard unit								
Circuit 1 ^(a)	kW	200	225	267	286	309	459	366
Circuit 2 ^(a)	kW	294	312	286	307	309	230	366
Option 081	kW	488	537	553	593	619	689	
Unit + option 15LS								
Circuit 1 ^(a)	kW	190	220	258	276	299	451	354
Circuit 2 ^(a)	kW	277	303	276	297	299	222	354
Option 081	kW	467	524	534	574	598	666	
Power factor at maximum power⁽¹⁾								
Standard unit								
Displacement Power Factor (Cos Phi)		0,88	0,88	0,88	0,88	0,88	0,89	0,89
Unit + option 15LS								
Displacement Power Factor (Cos Phi)		0,88	0,88	0,88	0,88	0,88	0,89	0,89
Nominal operating current draw⁽²⁾								
Standard unit								
Circuit 1 ^(a)	A	261	274	341	356	390	543	446
Circuit 2 ^(a)	A	364	392	356	386	390	273	446
Option 081	A	625	666	697	742	780	820	
Unit + option 15LS								
Circuit 1 ^(a)	A	247	265	325	340	372	530	427
Circuit 2 ^(a)	A	344	376	340	370	372	260	427
Option 081	A	590	641	665	710	745	782	
Maximum operating current draw (Un)⁽¹⁾								
Standard unit								
Circuit 1 ^(a)	A	323	366	440	470	509	740	593
Circuit 2 ^(a)	A	472	509	470	505	509	370	593
Option 081	A	787	877	912	977	1020	1113	
Unit + option 15LS								
Circuit 1 ^(a)	A	309	357	424	454	491	727	574
Circuit 2 ^(a)	A	452	493	454	489	491	357	574
Option 081	A	762	852	880	945	985	1074	

(1) Values obtained at unit continuous maximum operating conditions (data given on the unit nameplate)

(2) Operating current of the smallest compressor(s) + fan current + locked rotor current or reduced start-up current of the largest compressor.

(a) When the machines are equipped with two power supplies, circuit 1 supplies the refrigerant circuit A and circuit 2 supplies the refrigerant circuit B or for units 30XB1550 to 1700 units: Circuit 1 supplies circuits A and B, circuit 2 supplies circuits C and D.

4 - PHYSICAL AND ELECTRICAL DATA FOR 30XB UNITS

4.5 - Electrical data (continued)

30XB from 1100 to 1700 with option 254 or 255 (continued)

30XB with option 254 or 255		1100	1200	1300	1400	1500	1550	1700
Maximum current (Un-10%)⁽¹⁾								
Standard unit								
Circuit 1 ^(a)	A	319	366	440	470	509	740	593
Circuit 2 ^(a)	A	464	509	470	505	509	370	593
Option 081	A	785	877	912	977	1020	1113	
Unit + option 15LS								
Circuit 1 ^(a)	A	309	357	424	454	491	727	574
Circuit 2 ^(a)	A	452	493	454	489	491	357	574
Option 081	A	762	850	880	945	985	1074	
Nominal start-up current⁽³⁾								
Standard unit								
Circuit 1 ^(a)	A	590	587	629	629	629	954	812
Circuit 2 ^(a)	A	635	629	629	629	629	477	812
Option 081	A	949	986	985	1015	1019	1316	
Option 081 & Opt 25c	A	811	820	844	862	862		
Unit + option 15LS								
Circuit 1 ^(a)	A	576	578	613	613	611	941	793
Circuit 2 ^(a)	A	615	613	613	613	611	464	793
Option 081	A	1020	1070	1063	1098	1099	1393	
Option 081 & Opt 25c	A	776	795	812	830	826		
Maximum start-up current(Un)⁽²⁾								
Standard unit								
Circuit 1 ^(a)	A	590	590	629	629	629	954	812
Circuit 2 ^(a)	A	635	632	629	629	629	477	812
Option 081	A	1055	1101	1095	1130	1134	1431	
Option 081 & Opt 25c	A	811	820	844	862	862		
Unit + option 15LS								
Circuit 1 ^(a)	A	576	578	613	613	611	941	793
Circuit 2 ^(a)	A	615	613	613	613	611	464	793
Option 081	A	1020	1070	1063	1098	1099	1393	
Option 081 & Opt 25c	A	776	795	812	830	826		

(1) Values obtained at unit continuous maximum operating conditions (data given on the unit nameplate)

(2) Operating current of the smallest compressor(s) + fan current + locked rotor current or reduced start-up current of the largest compressor.

(3) Standardised EUROVENT conditions, water-cooled exchanger water inlet/outlet = 12°C/7°C, outdoor air temperature = 35°C.

(a) When the machines are equipped with two power supplies, circuit 1 supplies the refrigerant circuit A and circuit 2 supplies the refrigerant circuit B or for units 30XB1550 to 1700 units: Circuit 1 supplies circuits A and B, circuit 2 supplies circuits C and D.

4.6 - Compressor electrical data

Compressor	I Nom ⁽¹⁾	I Max (Un) ⁽²⁾	I Max (Un - 10%) ⁽³⁾	LRYA A ⁽⁴⁾	LRDA A ⁽⁵⁾	Cos Phi nom. ⁽⁶⁾	Cos Phi Max. ⁽⁷⁾
06TSA155	64	93	99	170	530	0,87	0,9
06TSA186	80	111	118	170	530	0,86	0,89
06TTA266	117	162	172	303	945	0,86	0,9
06TTA301	132	177	188	388	1210	0,87	0,9
06TTA356	153	207	220	388	1210	0,87	0,9
06TUA483	225	292	311	587	1828	0,87	0,88
06TUA554	241	338	360	587	1828	0,88	0,89
06TVA680	302	400	436	629	1919	0,87	0,89
06TVA753	315	430	468	629	1919	0,88	0,89
06TVA819	347	465	496	629	1919	0,88	0,89

Legend

(1) Nominal current draw at standard Eurovent conditions (see definition of conditions under nominal unit current draw)

(2) Maximum operating current

(3) Maximum compressor operating current, limited by the unit (current given for maximum capacity at 360 V)

(4) Locked rotor current for star connection (connection during compressor start-up)

(5) Locked rotor current for delta connection

(6) Value at standard Eurovent conditions: evaporator entering/leaving water temperature 12°C/7°C, condenser entering/leaving water temperature 30°C/35°C.

(7) Value at maximum capacity and nominal voltage

4 - PHYSICAL AND ELECTRICAL DATA FOR 30XB UNITS

4.7 - Compressor usage per circuit (A, B, C, D)

Compresseur	Circuit	250	300	350	400	450	500	600	700	750	800	850	900	1000	1100	1200	1300	1400	1500	1550	1700	
06TSA155	A	1																				
	B	1	1		1																	
06TSA186	A		1	1		1	1															
	B			1																		
06TTA266	A				1																	
	B																					
06TTA301	A					1																
	B							1		1												
06TTA356	A						1	1	1													
	B								1		1	1										1
	D								1		1	1										1
06TUA483	A									1	1		1		1							
	B												1									
06TUA554	A											1		1		1					1	1
	B													1							1	
	C																				1	1
06TVA680	A																1					
	B																					
06TVA753	A																	1				
	B														1		1					
06TVA819	A																				1	
	B															1		1		1		

Electrical data notes and operating conditions for 30XB units:

- 30XB&XBP 250 to 1000 units have a single power connection point; 30XB & XBP 1100 to 1700 units have two connection points.
- The control box includes the following standard features:
 - One general disconnect switch per circuit
 - Starter and motor protection devices for each compressor, the fan(s) and the pump
 - Control devices

Field connections:

- All connections to the system and the electrical installations must be in full accordance with all applicable local codes.
- The Carrier 30XB & 30XBP units are designed and built to ensure conformance with these codes. The recommendations of European standard EN 60204-1 (corresponds to IEC 60204-1) (machine safety - electrical machine components - part 1: General regulations) are specifically taken into account, when designing the electrical equipment.

IMPORTANT:

- Generally the recommendations of IEC 60364 are accepted as compliance with the requirements of the installation regulations.
 - Conformance with EN 60204 is the best means of ensuring compliance with the Machines Directive ~ 1.5.1. Annex B of EN 60204-1 describes the electrical characteristics used for the operation of the machines.
1. Environment* . Environment as classified in EN 60364 (corresponds to IEC 60364):
 - Outdoor installation*
 - Ambient temperature range: from -20°C to +55°C**
 - Altitude less than or equal to 2000 m (for hydraulic module, see paragraph 4.7 in the IOM)
 - Presence of hard solids, class AE3 (no significant dust present)*
 - Presence of corrosive and polluting substances, class AF1 (negligible)
 - Competence of persons: BA4 (Persons wise); 30XB & 30XBP machines are not intended to be installed in locations open to anyone, including people with disabilities and children.
 2. Compatibility for low-frequency conducted disturbances according to IEC61000-2-2 and to class 2 levels per IEC61000-2-4 standard:
 - Power supply frequency variation : +2Hz
 - Phase imbalance : 2%
 - Total Voltage Harmonic Distortion (THDV) : 8%
 3. The neutral (N) line must not be connected directly to the unit (if necessary use a transformer).

4. Overcurrent protection of the power supply conductors is not provided with the unit.
 5. The factory installed disconnect switch(es)/circuit breaker(s) is (are) of a type suitable for power interruption in accordance with EN 60947-3 (corresponds to IEC 60947-3).
 6. The units are designed for simplified connection on TN(s) networks (IEC 60364). For IT networks provide a local earth and consult competent local organisations to complete the electrical installation. Units delivered with variable frequency drive(s) (options : 28, 17) are not compatible with IT network. 30XB units are designed to use for domestic / residential and industrial environments: Machines that are not equipped with variable frequency drive(s) are in accordance with the codes :
 - 61000-6-3: General standards - Standard emission for residential, commercial and light industry.
 - 61000-6-2: General standards - Immunity for industrial environments. Machines that are equipped with variable frequency drive(s) (options : 28, 17) are in accordance with standard EN61800 - 3 electric power variable speed drives - art 3: EMC requirements and specific test methods for the following classifications:-
 - Use in the first and second environments***.
 - Category C2 applicable in the first environment, on stationary devices designed to be installed and commissioned by a professional. Warning: In a residential environment, this product may cause radio interference in which case additional mitigation measures could be required.
 - Leakage currents: If protection by monitoring the leakage currents is necessary to ensure the safety of the installation, the presence of additional leakage currents introduced by the use of variable frequency drive(s) in the unit must be considered. In particular these protection devices shall be of reinforced immunity types and have a threshold not lower than 150 mA.
 - Capacitors that are integrated as part of the option 231 can generate electrical disturbances in the installation the unit is connected to. Presence of these capacitors must be considered during the electrical study prior to the start-up.
- NOTE:** If particular aspects of an actual installation do not conform to the conditions described above, or if there are other conditions which should be considered, always contact your local Carrier representative.
- * The required protection level for this class is IP43BW (according to reference document IEC 60529). All 30XB & XBP units are protected to IP44CW and fulfil this protection condition.
- ** The maximum ambient temperature allowed for machines equipped with option 231 is +40°C

4 - PHYSICAL AND ELECTRICAL DATA FOR 30XB UNITS

4.8 - Electrical data, optional hydraulic module

The pumps that are factory-installed in these units comply with the European Ecodesign directive ErP. The additional electrical data required⁽¹⁾ is as follows:

Motors of single and dual low-pressure pumps for 30XB units (options 116F and 116G)

No. ⁽²⁾	description ⁽³⁾		250	300	350	400	450	500
1	Nominal efficiency at full load and nominal voltage	%	86,7	86,7	87,2	88,1	89,4	89,4
1	Nominal efficiency at 75% full load and nominal voltage	%	87,0	87,0	86,9	88,0	88,9	88,9
1	Nominal efficiency at 50% full load and nominal voltage	%	85,5	85,5	84,5	86,1	86,7	86,7
2	Efficiency level	-	IE3					
3	Year of manufacture	-	This information varies depending on the manufacturer and model at the time of incorporation. Please refer to the motor nameplates.					
4	Company name or trademark, commercial registration number and head office of manufacturer	-	Same as above					
5	Product model number	-	Same as above					
6	Number of motor poles	-	2					
7-1	Nominal shaft power output at full load and nominal voltage (400 V)	kW	2,2	2,2	3,0	4,0	5,5	5,5
7-2	Maximum input power (400V) ⁽⁴⁾	kW	2,54	2,54	3,44	4,54	6,15	6,15
8	Nominal input frequency	Hz	50					
9-1	Nominal voltage	V	3*400					
9-2	Maximum current drawn (400V) ⁽⁵⁾	A	4,2	4,2	5,5	7,4	9,7	9,7
10	Nominal speed	r/s - r/min	48 - 2900	48 - 2900	49 - 2915	49 - 2915	49 - 2930	49 - 2930
11	product disassembly, recycling or disposal at end of life	-	Disassembly using standard tools. Disposal and recycling using an appropriate company.					
12	Operating conditions for which the motor is specifically designed							
	I - Altitudes above sea level	m	< 1000 ⁽⁶⁾					
	II - Ambient air temperature	°C	< 40					
	III - Maximum operating temperature	°C	Please refer to the operating conditions given in this manual or in the specific conditions given in the Carrier selection programs.					
	IV - Potentially explosive atmospheres	-	Non ATEX environment					

Motors of single and dual high-pressure pumps for 30XB units (options 116B and 116C)

No. ⁽²⁾	description ⁽³⁾		250	300	350	400	450	500
1	Nominal efficiency at full load and nominal voltage	%	88,1	89,4	89,4	90,1	91,3	91,3
1	Nominal efficiency at 75% full load and nominal voltage	%	88,0	88,9	88,9	89,7	91,4	91,4
1	Nominal efficiency at 50% full load and nominal voltage	%	86,1	86,7	86,7	87,9	90,3	90,3
2	Efficiency level	-	IE3					
3	Year of manufacture	-	This information varies depending on the manufacturer and model at the time of incorporation. Please refer to the motor nameplates.					
4	Company name or trademark, commercial registration number and head office of manufacturer	-	Same as above					
5	Product model number	-	Same as above					
6	Number of motor poles	-	2					
7-1	Nominal shaft power output at full load and nominal voltage (400 V)	kW	4	5,5	5,5	7,5	11	11
7-2	Maximum input power (400V) ⁽⁴⁾	kW	4,5	6,2	6,2	8,3	12,0	12,0
8	Nominal input frequency	Hz	50					
9-1	Nominal voltage	V	3*400					
9-2	Maximum current drawn (400V) ⁽⁵⁾	A	7,4	9,7	9,7	13,2	18,7	18,7
10	Nominal speed	r/s - r/min	49 - 2915	49 - 2930	49 - 2930	49 - 2935	49 - 2945	49 - 2945
11	product disassembly, recycling or disposal at end of life	-	Disassembly using standard tools. Disposal and recycling using an appropriate company.					
12	Operating conditions for which the motor is specifically designed							
	I - Altitudes above sea level	m	< 1000 ⁽⁶⁾					
	II - Ambient air temperature	°C	< 40					
	III - Maximum operating temperature	°C	Please refer to the operating conditions given in this manual or in the specific conditions given in the Carrier selection programs.					
	IV - Potentially explosive atmospheres	-	Non ATEX environment					

(1) Required by regulation No. 640/2009 concerning the application of directive 2009/125/EC on the eco-design requirements for electric motors.

(2) Item number imposed by regulation No. 640/2009, annex I2b.

(3) Description given by regulation No. 640/2009, annex I2b.

(4) To obtain the maximum input power for a unit with hydraulic module, add the maximum unit input power from the electrical data table to the pump power input.

(5) To obtain the maximum unit operating current draw for a unit with hydraulic module, add the maximum unit current draw from the electrical data table to the pump current draw.

(6) Above 1000 m, a degradation of 3% for each 500 m should be taken into consideration.

5 - ELECTRICAL CONNECTION

Please refer to the certified dimensional drawings, supplied with the unit.

5.1 - Power supply

The power supply must conform to the specification on the chiller nameplate. The supply voltage must be within the range specified in the electrical data table. For connections refer to the wiring diagrams and the certified dimensional drawings.

WARNING: Operation of the chiller with an improper supply voltage or excessive phase imbalance constitutes abuse which will invalidate the Carrier warranty. If the phase imbalance exceeds 2% for voltage, or 10% for current, contact your local electricity supply at once and ensure that the chiller is not switched on until corrective measures have been taken.

5.2 - Voltage phase imbalance (%)

$$\frac{100 \times \text{max. deviation from average voltage}}{\text{Average voltage}}$$

Example:

On a 400 V - 3 ph - 50 Hz supply, the individual phase voltages were measured to be:

$$\begin{aligned} AB &= 406 \text{ V}; BC = 399; AC = 394 \text{ V} \\ \text{Average voltage} &= (406 + 399 + 394)/3 = 1199/3 \\ &= 399.7 \text{ say } 400 \text{ V} \end{aligned}$$

Calculate the maximum deviation from the 400 V average:

$$\begin{aligned} (AB) &= 406 - 400 = 6 \\ (BC) &= 400 - 399 = 1 \\ (CA) &= 400 - 394 = 6 \end{aligned}$$

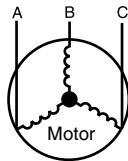

The maximum deviation from the average is 6 V. The greatest percentage deviation is: $100 \times 6/400 = 1.5 \%$

This is less than the permissible 2% and therefore acceptable.

5.3 - Power connection/disconnect switch

Units	Connection points
30XB-250 to 1000	1 per unit
30XB-1100 to 1700	1 for circuit 1 1 for circuit 2

5.4 - Recommended wire sections

Wire sizing is the responsibility of the installer, and depends on the characteristics and regulations applicable to each installation site. The following is only to be used as a guide-line, and does not make in any way liable. After wire sizing has been completed, using the certified dimensional drawing, the installer must ensure easy connection and define any modifications necessary on site.

The connections provided as standard for the field-supplied power entry cables to the general disconnect/isolator switch are designed for the number and type of wires, listed in column 2 of the table on the next page.

The calculations are based on the maximum machine current (see electrical data tables).

The calculations for favourable and unfavourable cases are based on the maximum current for each unit (see electrical data tables). For the design the standardised installation methods in accordance with IEC 60364 are used: PVC (70 °C) or XLPE (90 °C) insulated cables with copper core; arrangement to comply with table 52c of the above standard. The maximum temperature is 46 °C. The given maximum length is calculated to limit the voltage drop to 5%.

IMPORTANT: Before connection of the main power cables (L1 - L2 - L3) on the terminal block, it is imperative to check the correct order of the 3 phases before proceeding to the connection on then terminal block or the main disconnect/isolator switch.

5.5 - Power cable entry

The power cables can enter the 30XB control box from below or from the unit side. For 30XB unit sizes 600 to 1700 the control box that includes the power supply cable connection terminal is located in the lower part of the unit. In this case the control box is raised by 120 mm compared to the lowest point of the chassis.

The cable entry point depends on the unit configuration:

1. Unit raised from the ground (e.g. installation on support rails): It is recommended to enter the power cables from below the control box. A removable aluminium plate below the control box allows introduction of the cables.
2. Unit placed on the ground: For power cable entry from below the control box ensure that the cable bend radius is compatible with the connection space available in the control box. If not, an aluminium plate on the control box face allows introduction of the cables.

For units with three circuits with option 81 (single power connection point) the connection must be made from below the unit.

IMPORTANT: Check the cable bend radius for cable entry into a control box, located in the lower part of the unit.

Refer to the certified dimensional drawing for the unit.

5 - ELECTRICAL CONNECTION

5.6 - Field control wiring

IMPORTANT: Field connection of interface circuits may lead to safety risks: Any control box modification must maintain equipment conformity with local regulations. Precautions must be taken to prevent accidental electrical contact between circuits supplied by different sources:

- **The routing selection and/or conductor insulation characteristics must ensure dual electric insulation.**
- **In case of accidental disconnection, conductor fixing between different conductors and/or in the control box prevents any contact between the conductor ends and an active energised part.**

Refer to the 30XB/30XAS/30XW Touch Pilot control manual and the certified wiring diagram supplied with the unit for the field control wiring of the following features:

- Remote on/off switch
- Demand limit external switch
- Remote dual set point
- Alarm, alert and operation report
- Evaporator pump control
- Heat reclaim condenser pump control (option)
- Hot water valve control (option)
- Set point reset via outside air temperature sensor reset
- Various interlocks on the Energy ManagementModule (EMM) board (option).

Selection of minimum and maximum wire sections for connection to 30XB units

30XB/30XBP	Max. connectable wire section ⁽¹⁾	Calculation of favourable case: -Suspended overhead/aerial line (standardised routing no. 17) -90°C insulated cable - Copper conductor (Cu)			Calculation of unfavourable case: - Conductors in ducts or multi-conductor cables in closed conduit (standardised routing No. 41) -70°C insulated cable if possible - Copper conductor (Cu)		
		Calculation of favourable case: - Perforated horizontal conduit (standardised routing No. 13/15) - 90°C insulated cable - Copper conductor (Cu)			Calculation of unfavourable case: - Closed conduit (standardised routing No. 41) - 70°C insulated cable if possible - Copper conductor (Cu)		
		Section ⁽²⁾	Max. length for a voltage drop <5%	Cable type	Section ⁽²⁾	Max. length for a voltage drop <5%	Cable type
	qty x mm ² (per phase)	qty x mm ² (per phase)	m	-	qty x mm ² (per phase)	m	-
Standard unit							
250	2 x 185	1 x 95	190	XLPE Cu	2 x 95	450	PVC Cu
300	2 x 185	1 x 95	190	XLPE Cu	2 x 95	420	PVC Cu
350	2 x 185	1 x 120	197	XLPE Cu	2 x 95	390	PVC Cu
400	2 x 185	1 x 150	200	XLPE Cu	2 x 120	400	PVC Cu
450	2 x 185	1 x 185	205	XLPE Cu	2 x 150	420	PVC Cu
500	2 x 185	1 x 240	205	XLPE Cu	2 x 185	430	PVC Cu
600	2 x 240	2 x 95	190	XLPE Cu	2 x 240	440	PVC Cu
700	2 x 240	2 x 120	198	XLPE Cu	2 x 185	330	XLPE Cu
750	2 x 240	2 x 120	198	XLPE Cu	2 x 240	370	XLPE Cu
800	2 x 240	2 x 150	200	XLPE Cu	2 x 240	330	XLPE Cu
850	2 x 240	2 x 150	200	XLPE Cu	2 x 240	320	XLPE Cu
900	2 x 240	2 x 185	205	XLPE Cu	Not compatible - -		
1000	4 x 300	2 x 240	205	XLPE Cu	4 x 185	320	XLPE Cu
1100	2x240/3x240	1x185/2x120	291/240	XLPE Cu	2x240/3x240	600/530	PVC Cu/PVC Cu
1200	2x240/3x240	1x240/2x150	310/270	XLPE Cu	2x150/2x240	380/380	XLPE Cu/XLPE/Cu
1300	2x240/3x240	2x120/2x120	260/240	XLPE Cu	2x240/2x240	420/400	XLPE Cu/XLPE Cu
1400	2x240/3x240	2x120/2x150	240/270	XLPE Cu	2x240/2x240	400/380	XLPE Cu/XLPE Cu
1500	2x240/3x240	2x120/2x150	240/270	XLPE Cu	2x240/2x240	400/380	XLPE Cu/XLPE Cu
1550	4 x 300 /2 x240	2 x 300/1 x 240	300/310	XLPE Cu	4x 240 /2x 150	400/380	XLPE Cu/XLPE Cu
1700	2 x 240 /2 x240	2 x 185/2 x 185	260/260	XLPE Cu	Not compatible -		
30XB & 30XBP + option081							
1100 to 1500	5x240						
1550	8x240						

(1) Connection capacities actually available for each machine. These are defined according to the connection terminal size, the electrical/control box access opening dimensions and the available space inside the electrical/control box.

(2) Selection simulation result considering the hypotheses indicated.

(3) If the maximum calculated section is for an 90°C cable type, this means that a selection based on a 70°C cable type can exceed the connection capacity actually available. Special attention must be given to selection.

The protection against direct contact at the electrical connection point is compatible with the addition of terminals extension. The installer must determine whether these are necessary based on the cable sizing calculation.

NOTE: The currents considered are given for a machine equipped with an hydraulic module operating at maximum current.

6 - APPLICATION DATA

6.1 - Operating range

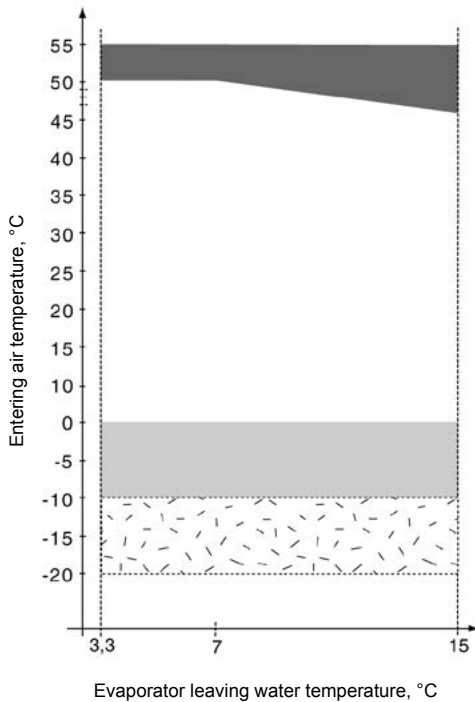

30XB & 30XBP

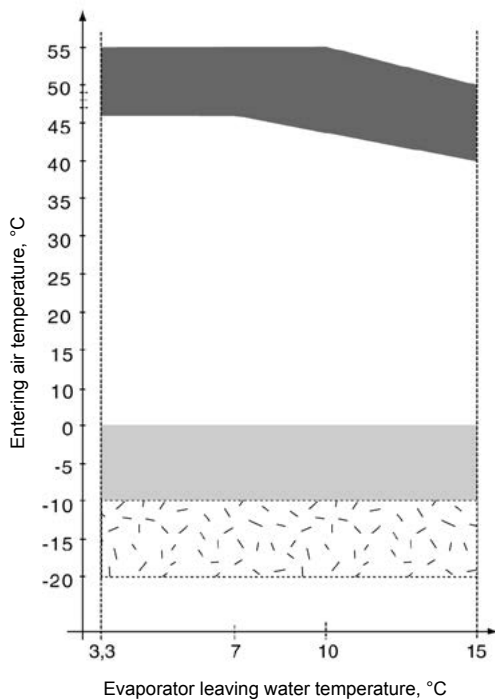

30XB & 30XBP with option 15LS



Legend:

-  Operating range, unit equipped with option 28 (winter operation).
-  Below 0 °C air temperature the unit must either be equipped with the evaporator frost protection option (41A or 41B), or the water loop must be protected against frost by using a frost protection solution (by the installer).
-  Part load average

ATTENTION: Option 28 (Winter operation)

If the outside temperature is below -10 °C and the unit has been switched off for more than 4 hours, it is necessary to wait 2 hours after the unit has been switched on again to allow the frequency converter to warm up.

Water heat exchanger	Minimum	Maximum	
Entering temperature at start-up	°C	-	45(1)
Leaving temperature during operation	°C	3,3	15
Entering/leaving water temperature difference	K	2,8	10
Condenser air temperature	Minimum	Maximum	
Storage	-20	68	
Operation, standard unit	-10	55(2)	
With winter operation option (option 28)	-20	55(2)	
With Low noise option (option 15LS)	-10	52(2)	

Note: If the air temperature is below 0°C, a glycol/water solution or the frost protection option must be used.

Note: If the leaving water temperature is below 4°C, a glycol/water solution or the frost protection option must be used.

- (1) Based on the installation type and the air temperature
- (2) Part load, depended of sizes & leaving water temperature

6.2 - Minimum chilled water flow (units without hydraulic module)

The minimum chilled water flow is shown in the table on the next page. If the system flow is less than this, the evaporator flow can be recirculated, as shown in the diagram.

For minimum chilled water flow rate

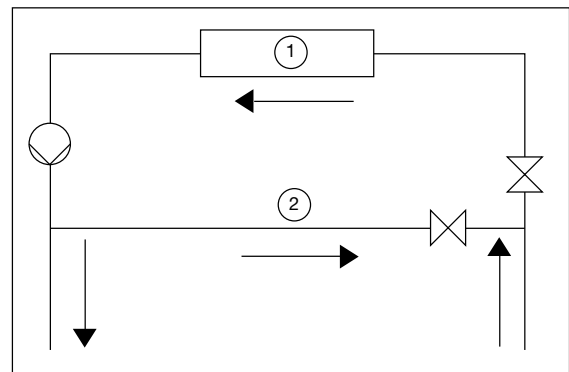

- 1 Evaporator
- 2 Recirculation

6.3 - Maximum chilled water flow (units without hydraulic module)

The maximum chilled water flow is shown in the table on the next page. If the system flow exceeds the maximum value, it can be bypassed as shown in the diagram.

For maximum chilled water flow rate

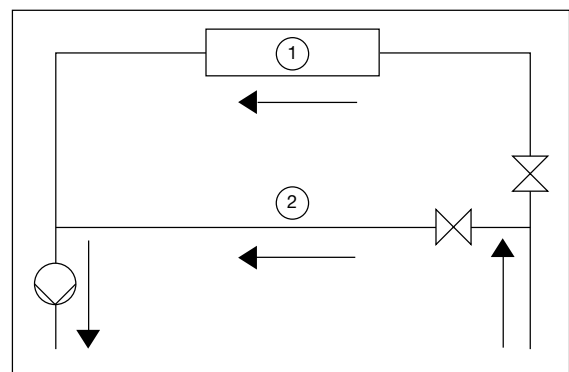

- 1 Evaporator
- 2 Bypass

6 - APPLICATION DATA

6.4 - Variable flow evaporator

Variable evaporator flow can be used in standard 30XB chillers. The chillers maintain a constant leaving water temperature under all flow conditions. For this to happen, the minimum flow rate must be higher than the minimum flow given in the table of permissible flow rates and must not vary by more than 10% per minute.

If the flow rate changes more rapidly, the system should contain a minimum of 6.5 litres of water per kW instead of 3.25 l/kW.

6.5 - System minimum water volume

Whichever the system, the water loop minimum capacity is given by the formula:

$$\text{Capacity} = \text{Cap (kW)} \times \text{N litres}$$

Application	N
Normal air conditioning	3,25
Process type cooling	6,5

Where Cap is the nominal system cooling capacity (kW) at the nominal operating conditions of the installation.

This volume is necessary for stable operation and accurate temperature control.

It is often necessary to add a buffer water tank to the circuit in order to achieve the required volume. The tank must itself be internally baffled in order to ensure proper mixing of the liquid (water or brine). Refer to the examples below.

Connection to a buffer tank

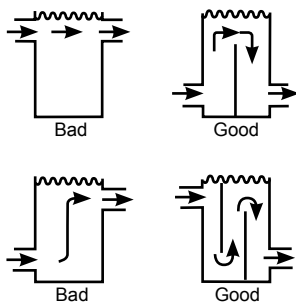

6.6 - Maximum system water volume

Units with hydraulic module incorporate an expansion tank that limits the water volume. The table below gives the maximum loop volume for pure water or ethylene glycol with various system concentrations, as well as the static pressures. If the maximum volume is insufficient, compared to the minimum system water loop volume, an additional expansion tank must be added to the system.

30XB & XBP	Static pressure bar	Sizes 250 to 450			500		
		1	2	2,5	1	2	2,5
Pure water	l	2400	1600	1200	3960	2640	1980
10% EG	l	1800	1200	900	2940	1960	1470
20% EG	l	1320	880	660	2100	1400	1050
30% EG	l	1080	720	540	1740	1160	870
40% EG	l	900	600	450	1500	1000	750

EG : Ethylene Glycol

6.7 - Evaporator water flow rate

30XB & 30XBP	Minimum flow rate ⁽¹⁾ (l/s)	Maximum flow rate ⁽²⁾ (l/s)
250	3,6	37,5
300	4,0	40,5
350	4,3	40,5
400	5,3	34,1
450	6,0	36,9
500	6,7	42,0
600	8,1	45,0
700	8,9	56,1
750	9,6	59,1
800	10,4	67,1
850	11,0	67,1
900	11,8	73,9
1000	13,1	83,9
1100	15,1	87,8
1200	16,4	126,5
1300	17,5	92,9
1400	16,4	132,1
1500	18,8	107,4
1550	19,9	109,4
1700	22,0	107,4

- (1) Minimum flow rate for maximum allowable water temperature difference conditions (10K) under Eurovent conditions
 (2) Maximum flow rate for a pressure drop of 100 kPa in the exchanger"

6 - APPLICATION DATA

6.8 - Evaporator pressure drop curve

Sizes 250 - 600

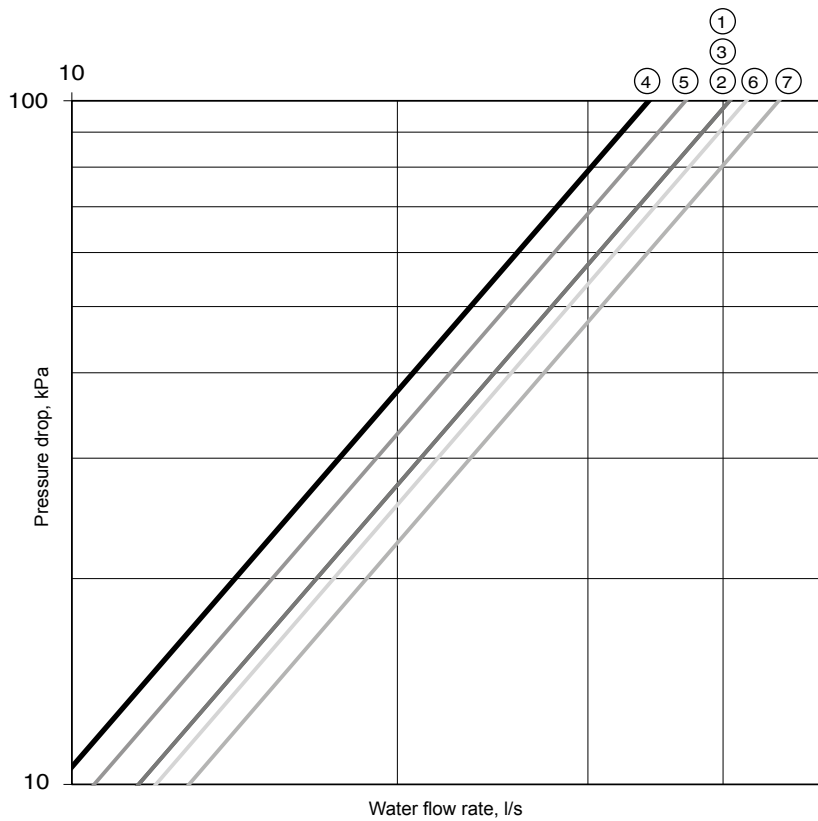

- Legend**
- 1 250
 - 2 300
 - 3 350
 - 4 400
 - 5 450
 - 6 500
 - 7 600

Sizes 700 - 1700

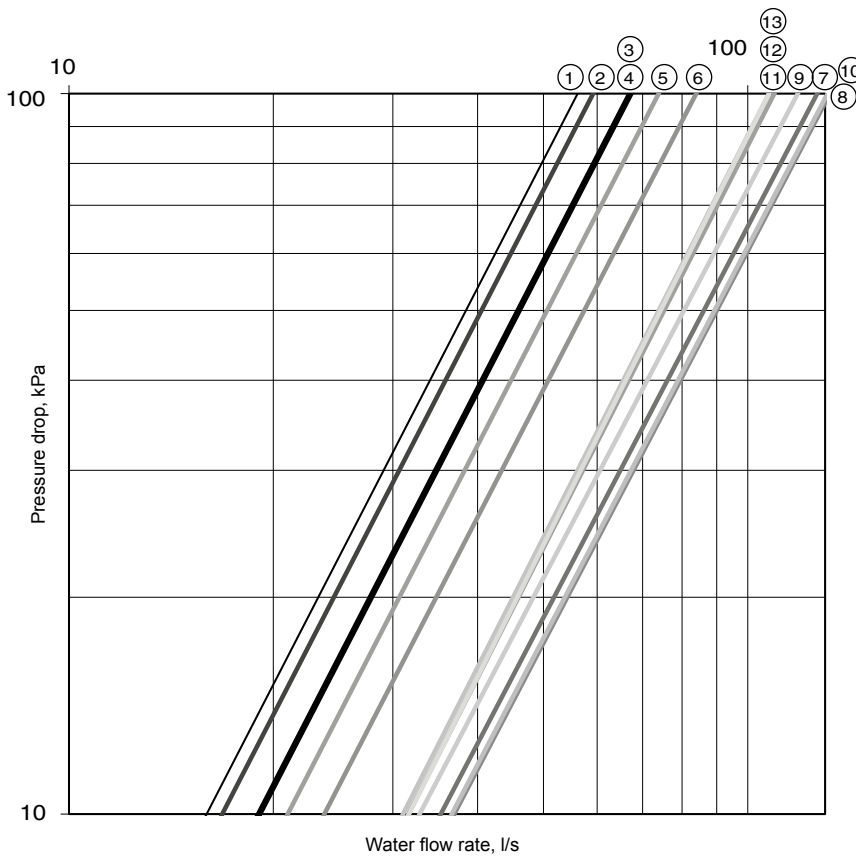

- Legend**
- 1 700
 - 2 750
 - 3 800
 - 4 850
 - 5 900
 - 6 1000
 - 7 1100
 - 8 1200
 - 9 1300
 - 10 1400
 - 11 1500
 - 12 1550
 - 13 1700

7 - WATER CONNECTIONS

ATTENTION: Before carrying out any water connections install the water box purge plugs (one plug per water box in the lower section - supplied in the control box).

For size and position of the heat exchanger water inlet and outlet connections refer to the certified dimensional drawings supplied with the unit.

The water pipes must not transmit any radial or axial force to the heat exchangers nor any vibration.

The water supply must be analysed and appropriate filtering, treatment, control devices, isolation and bleed valves and circuits built in, to prevent corrosion, fouling and deterioration of the pump fittings. Consult either a water treatment specialist or appropriate literature on the subject.

7.1 - Operating precautions

The water circuit should be designed to have the least number of elbows and horizontal pipe runs at different levels. Below the main points to be checked for the connection:

- Comply with the water inlet and outlet connections shown on the unit.
- Install manual or automatic air purge valves at all high points in the circuit(s).
- Use a pressure reducer to maintain pressure in the circuit(s) and install a relief valve as well as an expansion tank.
- Install thermometers in both the entering and leaving water connections.
- Install drain connections at all low points to allow the whole circuit to be drained.
- Install stop valves, close to the entering and leaving water connections.
- Use flexible connections to reduce the transmission of vibrations.
- Insulate all pipework, after testing for leaks, both to reduce heat gains and to prevent condensation.
- Cover the insulation with a vapour barrier.
- Where there are particles in the fluid that could foul the heat exchanger, a screen filter should be installed ahead of the pump, or directly at the exchanger inlet in case the pump is more than 20m away. The mesh size of the filter must be 1.2 mm (see 'Typical water circuit diagram').
- Before the system start-up verify that the water circuits are connected to the appropriate heat exchangers (e.g. no reversal between evaporator and condenser).
- Do not introduce any significant static or dynamic pressure into the heat exchange circuit (with regard to the design operating pressures).
- Before any start-up verify that the heat exchange fluid is compatible with the materials and the water circuit coating.
- The use of different metals on hydraulic piping could generate electrolytic pairs and consequently corrosion. Verify then, the need to install sacrificial anodes.

In case additives or other fluids than those recommended by Carrier are used, ensure that the fluids are not considered as a gas, and that they belong to class 2, as defined in directive 2014/68/EU.

Carrier recommendations on heat exchange fluids:

- No NH_4^+ ammonium ions in the water, they are very detrimental for copper. This is one of the most important factors for the operating life of copper piping. A content of several tenths of mg/l will badly corrode the copper over time.
- Cl^- Chloride ions are detrimental for copper with a risk of perforations by corrosion by puncture. If possible keep below 125 mg/l.
- SO_4^{2-} sulphate ions can cause perforating corrosion, if their content is above 30 mg/l.
- No fluoride ions (<0.1 mg/l)
- No Fe^{2+} and Fe^{3+} ions with non negligible levels of dissolved oxygen must be present. Dissolved iron < 5 mg/l with dissolved oxygen < 5 mg/l.
- Dissolved silica: silica is an acid element of water and can also lead to corrosion risks. Content < 1 mg/l.
- Water hardness: > 0.5 mmol/l. Values between 1 and 2.5 can be recommended. This will facilitate scale deposit that can limit corrosion of copper. Values that are too high can cause piping blockage over time. A total alkalimetric titre (TAC) below 100 is desirable.
- Dissolved oxygen: Any sudden change in water oxygenation conditions must be avoided. It is as detrimental to deoxygenate the water by mixing it with inert gas as it is to over-oxygenate it by mixing it with pure oxygen. The disturbance of the oxygenation conditions encourages destabilisation of copper hydroxides and enlargement of particles.
- Electric conductivity 10-600 $\mu\text{S}/\text{cm}$
- pH: Ideal case pH neutral at 20-25 °C $7.5 < \text{pH} < 9$.

If the water circuit must be emptied for longer than one month, the complete circuit must be placed under nitrogen charge to avoid any risk of corrosion by differential aeration.

ATTENTION: Filling, completing and draining the water circuit charge must be done by qualified personnel, using the air purges and materials that are suitable for the products.

Charging and removing heat exchange fluids should be done with devices that must be included on the water circuit by the installer. Never use the unit heat exchangers to add heat exchange fluid.

7 - WATER CONNECTIONS

7.2 - Victaulic water connections

Inlet/outlet diameters without hydraulic module

30XB		250	300	350	400	450	500	600	700	750	800
Standard & option 8											
Nominal diameter	in	5	5	5	5	5	5	5	6	6	6
Actual outside diameter	mm	141,3	141,3	141,3	141,3	141,3	141,3	141,3	168,3	168,3	168,3
Options 5, 6 et 100A											
Diamètre nominal	in	4	4	4	4	4	4	5	5	5	5
Actual outside diameter	mm	114,3	114,3	114,3	114,3	114,3	114,3	141,3	141,3	141,3	141,3
Options 100C**											
Nominal diameter	in	5	5	5	5	5	5	6	6	6	6
Actual outside diameter	mm	141,3	141,3	141,3	141,3	141,3	141,3	168,3	168,3	168,3	168,3

30XB		850	900	1000	1100	1200	1300	1400	1500	1550	1700
Standard & option 8											
Nominal diameter	in	6	6	8	6	6	6	6	6	8/6	6
Actual outside diameter	mm	168,3	168,3	219,1	168,3	168,3	168,3	168,3	168,3	219,1/168,3	168,3
Options 5, 6 et 100A											
Diamètre nominal	in	5	5	6	6	6	6	6	6	8/5	6/6
Actual outside diameter	mm	141,3	141,3	168,3	168,3	168,3	168,3	168,3	168,3	219,1/141,3	168,3/168,3
Options 100C											
Nominal diameter	in	6	6	8	-	-	-	-	-	-	-
Actual outside diameter	mm	168,3	168,3	219,1	-	-	-	-	-	-	-

* Option 100C is not available for sizes 1100 to 1700

Typical water circuit diagram

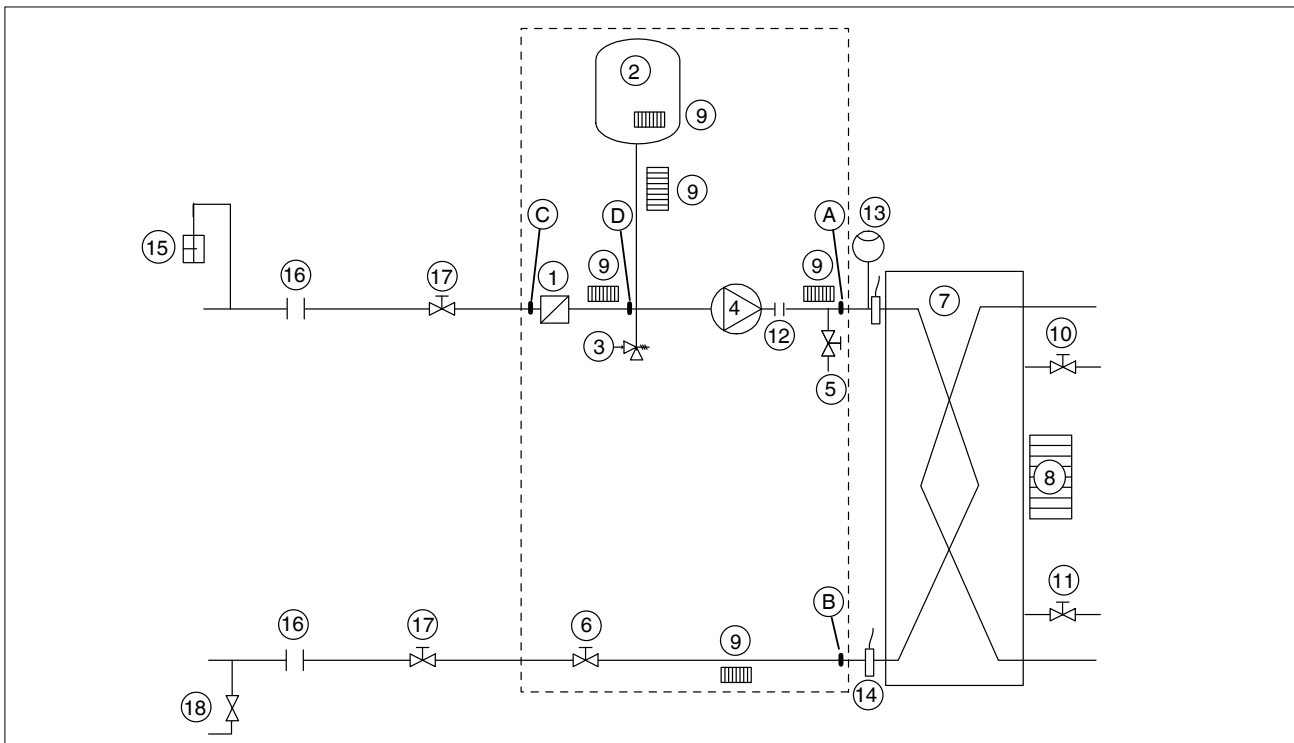

Legend

Components of the unit and hydraulic module

- | | |
|---|---|
| A Pressure sensor (A-B = ΔP evaporator) | 6 Flow control valve |
| B Pressure sensor | 7 Evaporator |
| C Pressure sensor (C-D = ΔP water filter) | 8 Evaporator defrost heater (option) |
| D Pressure sensor | 9 Hydraulic module defrost heater (option) |
| 1 Victaulic screen filter | 10 Air vent (evaporator) |
| 2 Expansion tank | 11 Water drain (evaporator) |
| 3 Relief valve | 12 Expansion compensator (flexible connections) |
| 4 Available pressure pump | 13 Flow switch |
| 5 Drain valve | 14 Water temperature sensor |

Installation components

- | |
|--|
| 15 Air vent |
| 16 Flexible connection |
| 17 Shut-off valve |
| 18 Charge valve |
| --- Hydraulic module (supplied as an option) |

7 - WATER CONNECTIONS

7.3 - Flow control

Evaporator flow switch and chilled water pump interlock

IMPORTANT: On 30XB & XBP units, the unit water flow switch must be energised. Failure to follow this instruction will void the Carrier guarantee.

The water flow switch is installed on the evaporator water inlet and adjusted by the control, based on unit size and application. If adjustment is necessary, it must be carried out by qualified personnel trained by Carrier Service.

7.4 - Evaporator water box bolt tightening

The evaporator (and condenser) are of the shell and tube type with removable water boxes to facilitate cleaning. Re-tightening or tightening must be done in accordance with the illustration below.

Water box tightening sequence

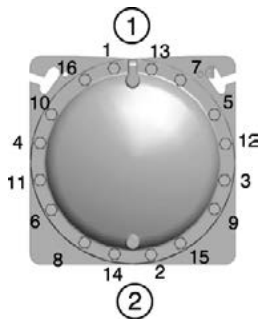

Legend:

- | | | | |
|---|----------------------------|---|------------------------------|
| 1 | Sequence 1: 1, 2, 3, 4 | 2 | Tightening torque |
| | Sequence 2: 5, 6, 7, 8 | | Bolt size M16 - 171 - 210 Nm |
| | Sequence 3: 9, 10, 11, 12 | | |
| | Sequence 4: 13, 14, 15, 16 | | |

NOTE: Before this operation we recommend draining the circuit and disconnecting the pipes to be sure that the bolts are correctly and uniformly tightened.

7.5 - Frost protection

7.5.1 - Standard machine

If the chiller or the water piping is in an area where the ambient temperature can fall below 0 °C it is recommended to add an antifreeze solution to protect the unit and the water piping to a temperature of 10 K below the lowest temperature likely to be reached at the installation site. Use only antifreeze solutions, approved for heat exchanger duty. If the system is not protected by an antifreeze solution and will not be used during the freezing weather conditions, draining of the cooler and outdoor piping is mandatory. Damage due to freezing is not covered by the warranty.

IMPORTANT: Depending on the climatic conditions in your area you must:

- Add ethylene glycol with an adequate concentration to protect the installation up to a temperature of 10 K below the lowest temperature likely to occur at the installation site.
- If the unit is not used for an extended period, it is recommended to drain it, and as a safety precaution add ethylene glycol to the heat exchanger, using the water entering purge valve connection (a purge connection is available somewhere on the heat exchanger water box in case the machine is not perfectly level).
- At the start of the next season, refill the unit with water and add an inhibitor.
- For the installation of auxiliary equipment, the installer must comply with basic regulations, especially for minimum and maximum flow rates, which must be between the values listed in the operating limit table (application data).

7.5.2 - Optional evaporator frost protection (30XB & XBP)

In cases where it is not possible to apply the recommendations in paragraph 7.5.1, the units can be equipped with heaters to protect the evaporator against frost (option 41A or 41B).

7.6 - Operation of two units in master/slave mode (option 58)

NOTE: This operating mode is not available for 30XB-1700 units.

The control of a master/slave assembly is in the entering water and does not require any additional sensors (standard configuration). It can also be located in the leaving water. In this case two additional sensors must be added on the common piping.

All parameters, required for the master/slave function must be configured using the Service Configuration menu. All remote controls of the master/slave assembly (start/stop, set point, load shedding etc.) are controlled by the unit configured as master and must only be applied to the master unit.

Each unit controls its own water pump. If there is only one common pump, in cases with variable flow, isolation valves must be installed on each unit. They will be activated at the opening and closing by the control of each heat pump (in this case the valves are controlled using the dedicated water pump outputs). Refer to the 30XB/30XAS/30XW Touch Pilot control manual for a more detailed explanation.

7 - WATER CONNECTIONS

30XB with configuration: Leaving water control

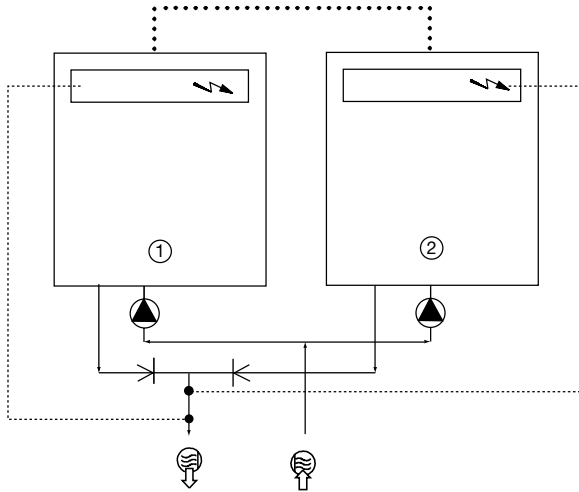

Legend

- ① Master unit
- ② Slave unit
- ⚡ Control boxes of the master and slave units
- ⦿ Water inlet
- ⦿ Water outlet
- ⦿ Water pumps for each unit (included as standard for units with hydraulic module)
- Additional sensors for leaving water control, to be connected to channel 1 of the slave boards of each master and slave unit
- ⋯ CCN communication bus
- Connection of two additional sensors

7.7 - Pump characteristics

7.7.1 - Available external static pressure (hydraulic module option)

Data applicable for:

- Fresh water 20 °C
- In case of use of the glycol, the maximum water flow is reduced.
- When the glycol is used, it's limited to 40%.

Single pump low pressure

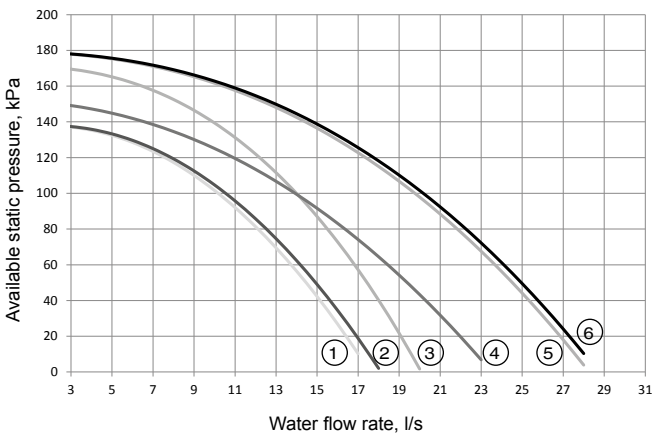

- | | |
|----------------|----------------|
| 1 30XB/XBP-250 | 4 30XB/XBP-400 |
| 2 30XB/XBP-300 | 5 30XB/XBP-450 |
| 3 30XB/XBP-350 | 6 30XB/XBP-500 |

Dual pump low pressure

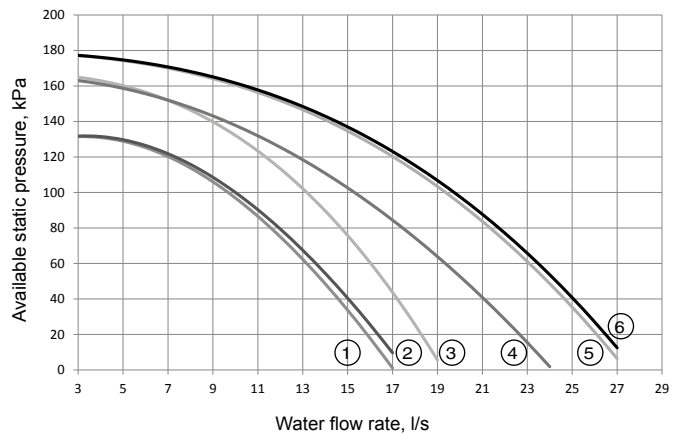

- | | |
|----------------|----------------|
| 1 30XB/XBP-250 | 4 30XB/XBP-400 |
| 2 30XB/XBP-300 | 5 30XB/XBP-450 |
| 3 30XB/XBP-350 | 6 30XB/XBP-500 |

Single pump high pressure

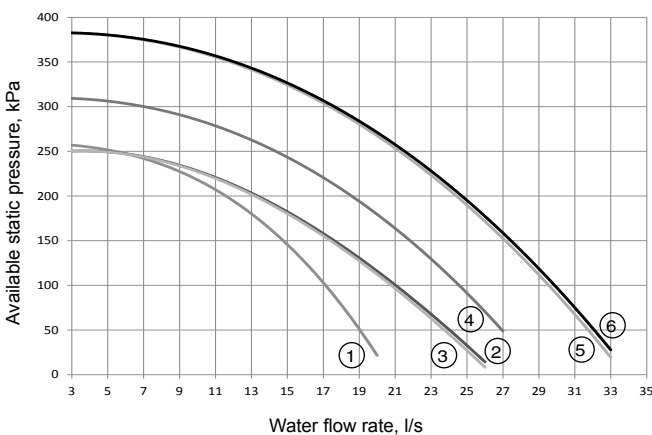

- | | |
|----------------|----------------|
| 1 30XB/XBP-250 | 4 30XB/XBP-400 |
| 2 30XB/XBP-300 | 5 30XB/XBP-450 |
| 3 30XB/XBP-350 | 6 30XB/XBP-500 |

Dual pump high pressure

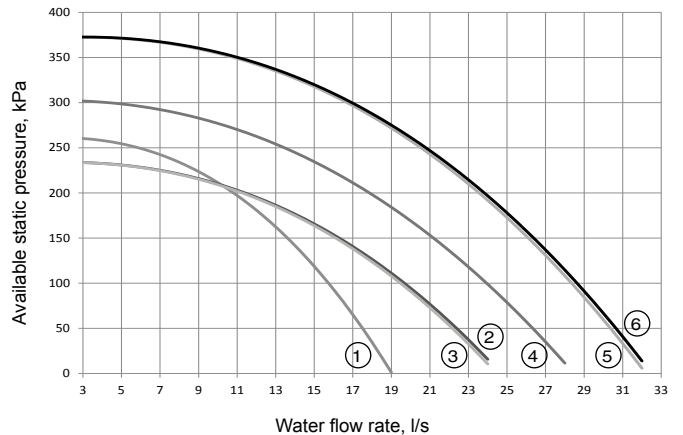

- | | |
|----------------|----------------|
| 1 30XB/XBP-250 | 4 30XB/XBP-400 |
| 2 30XB/XBP-300 | 5 30XB/XBP-450 |
| 3 30XB/XBP-350 | 6 30XB/XBP-500 |

7 - WATER CONNECTIONS

7.7.2 - Net positive suction head (NPSH) required, hydraulic module option

Size the hydraulic circuit to ensure a net positive suction head that is higher than or equal to the required NPSH + 50 kPa.

Data applicable for:

- Fresh water 20 °C
- In case of use of the glycol, the maximum water flow is reduced.
- When the glycol is used, it's limited to 40%.

Low-pressure pumps (options 116F/116G)

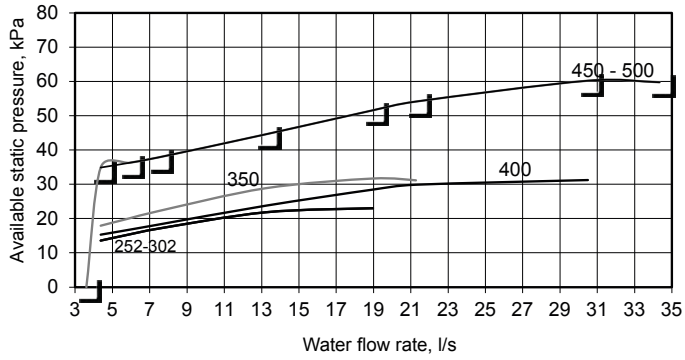

High-pressure pumps (options 116B/116C)

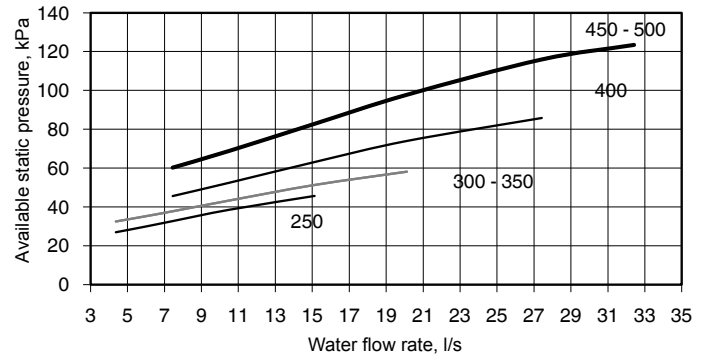

8 - FREE-COOLING OPTION (OPTION 118A)

8.1 - Physical data, 30XB units with free-cooling option (option 118A)

The option is available on the sizes 250 to 1000. The physical data of 30XB & 30XBP with Free cooling option (option 118A) are included in the paragraph 4.

8.2 - Operating limits

Cooling mode			
Evaporator		Minimum	Maximum
Entering water temperature at start-up	°C	-	45
Entering water temperature during operation	°C	6,8	21
Leaving water temperature during operation	°C	3,3	15
Condenser (air)			
Outdoor ambient operating temperature	°C	-10	55*
With winter operation option (option 28)	°C	-20	55*
Free-cooling mode			
Evaporator		Minimum	Maximum
Entering water temperature at start-up	°C	-	45
Leaving water temperature during operation	°C	3,3	26*
Condenser (air)			
Outdoor ambient operating temperature	°C	-10	20
With winter operation option (option 28)	°C	-20	20

* Maximum configurable set-point

8.3 - Operation

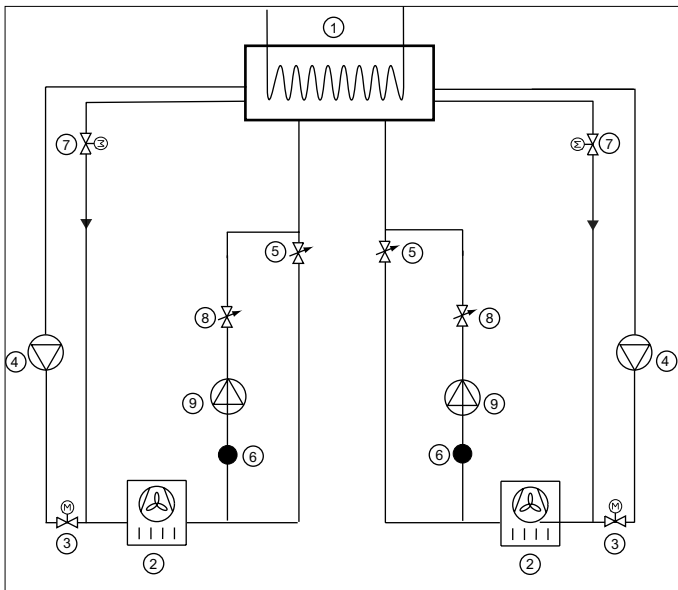

Legend

- 1 Evaporator
- 2 Air condenser (coils)
- 3 Motorised two-way valve, discharge side
- 4 Compressor and oil separator
- 5 Principal electronic expansion valve (EXV)
- 6 Pressure and temperature measurement to calculate the sub-cooling upstream of the pump
- 7 Motorised two-way bypass valve
- 8 Free-cooling expansion device (EXV)
- 9 Refrigerant pump

The change-over between the cooling and free-cooling modes is automatically controlled (it is possible to block the change-over to free-cooling by reconfiguring the machine - see Controls IOM). The configurable parameters permitting change-over are the outside air temperature and the leaving water temperature set-point. As soon as the temperature difference $LWT_{stp} - OAT$ is above 8 K the current capacity in cooling mode is calculated and compared with the theoretical free-cooling capacity. This comparison authorizes/stops the change-over to free-cooling.

After change-over to free-cooling all compressors are stopped, the two (or four) two-way valves change to the free-cooling position (the compressor functions are bypassed). As soon as the valves open, the free-cooling pump is started. This change-over logic takes around 4 minutes. Taking this timing into consideration two cooling - free-cooling change-overs are authorized per hour.

If the capacity supplied in the free-cooling mode is insufficient (set-point not reached), the unit automatically changes over to cooling mode.

To optimize operation in free-cooling mode we strongly recommend to use the set-point offset function. This favours the change-over to free-cooling and increases the capacity in free-cooling mode.

9 - HEAT RECLAIM CONDENSER OPTION (OPTION 50)

9.1 - Physical data, 30XB & XBP units with heat reclaim condenser option

30XB & XBP heat reclaim mode		250	300	350	400	450	500	600	700	750	800	850	900	1000
Operating weight*	kg	3370	3404	3425	4102	4245	4601	5551	5782	6065	6382	6430	6805	7272
Condenser diameter	in	10	10	10	12	14	14	12+12	12+12	14+12	14+12	14+12	14+14	14+14
Refrigerant charge														
Circuit A	kg	37	35	35	51	52	59	58	58	65	69	72	69	91
Circuit B	kg	39	37	37	37	37	36	59	62	58	65	63	76	89
Heat reclaim condenser		Flooded multi-pipe condenser												
Water volume	l	38	38	38	55	68	68	55+55	55+55	68 + 55	68 + 55	68 + 55	68+68	68+68
Water connections		Type Victaulic												
Nominal diameter	in	3	3	3	4	4	4	4	4	4	4	4	4	4
Actual outside diameter	mm	88,9	88,9	88,9	114,3	114,3	114,3	114,3	114,3	114,3	114,3	114,3	114,3	114,3

* Weights are for guidance only

9.2 - Dimensions, clearances

9.2.1 - 30XB-250 to 350 - heat reclaim option

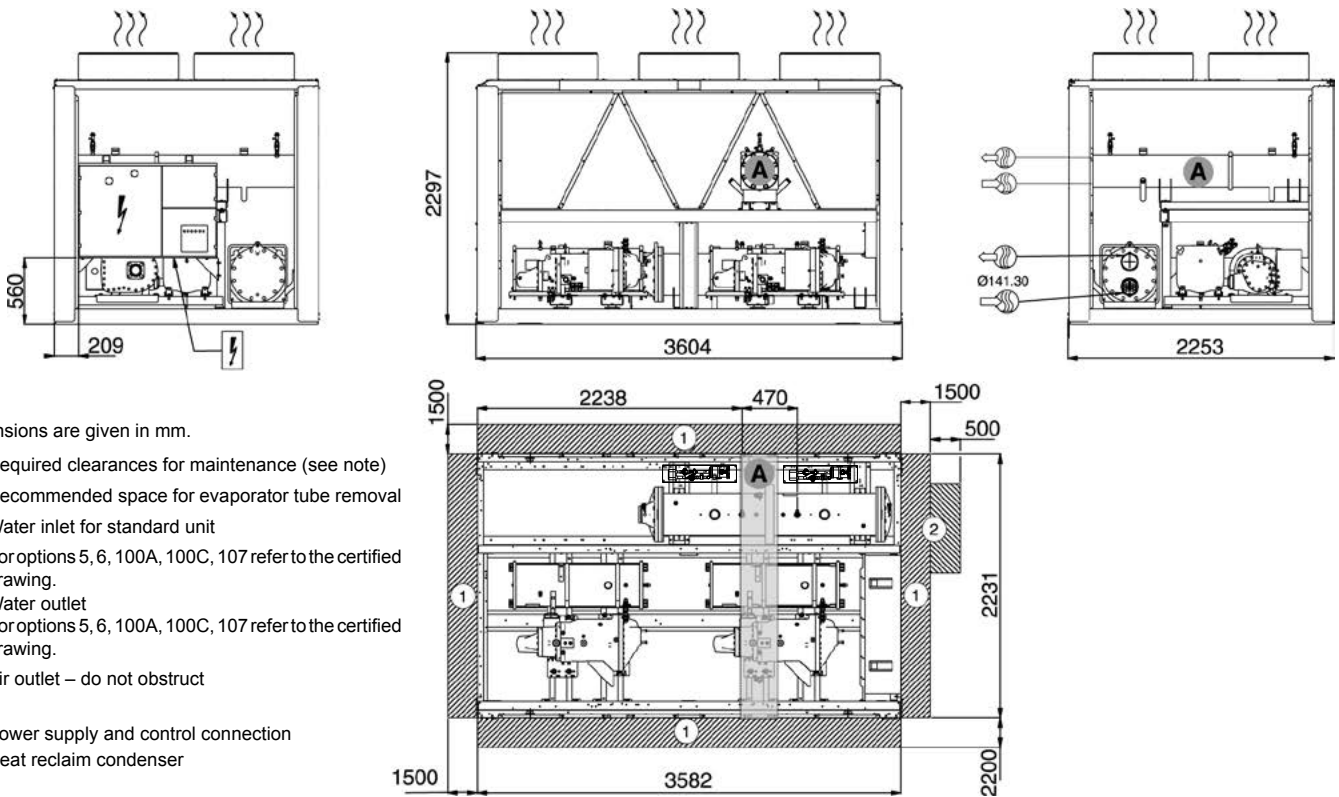

Legend

All dimensions are given in mm.

- ① Required clearances for maintenance (see note)
- ② Recommended space for evaporator tube removal
- ☰ Water inlet for standard unit
For options 5, 6, 100A, 100C, 107 refer to the certified drawing.
- ☱ Water outlet
For options 5, 6, 100A, 100C, 107 refer to the certified drawing.
- ☲ Air outlet – do not obstruct
- ⚡ Power supply and control connection
- A Heat reclaim condenser

ATTENTION: The condenser connection sleeves are not installed, but supplied with the unit. The sealing joints are in the control box. The temperature sensors and the condenser flow switch are wired and fixed in the machine. They must be installed as described in the chapter “Condenser water connections”.

NOTES:

- Drawings are not contractually binding.
- Before designing an installation, consult the certified dimensional drawings, available on request.
- For the positioning of the fixing points, weight distribution and centre of gravity coordinates please refer to the dimensional drawings.
- If the installation includes several units or if this (these) is (are) close to walls, please refer to chapters 3.11 - “Multiple chiller installation” and 3.12 - “Distance to the wall” of this document to determine the space required.

9 - HEAT RECLAIM CONDENSER OPTION (OPTION 50)

9.2.2 - 30XB & XBP-400 & 450 - heat reclaim option

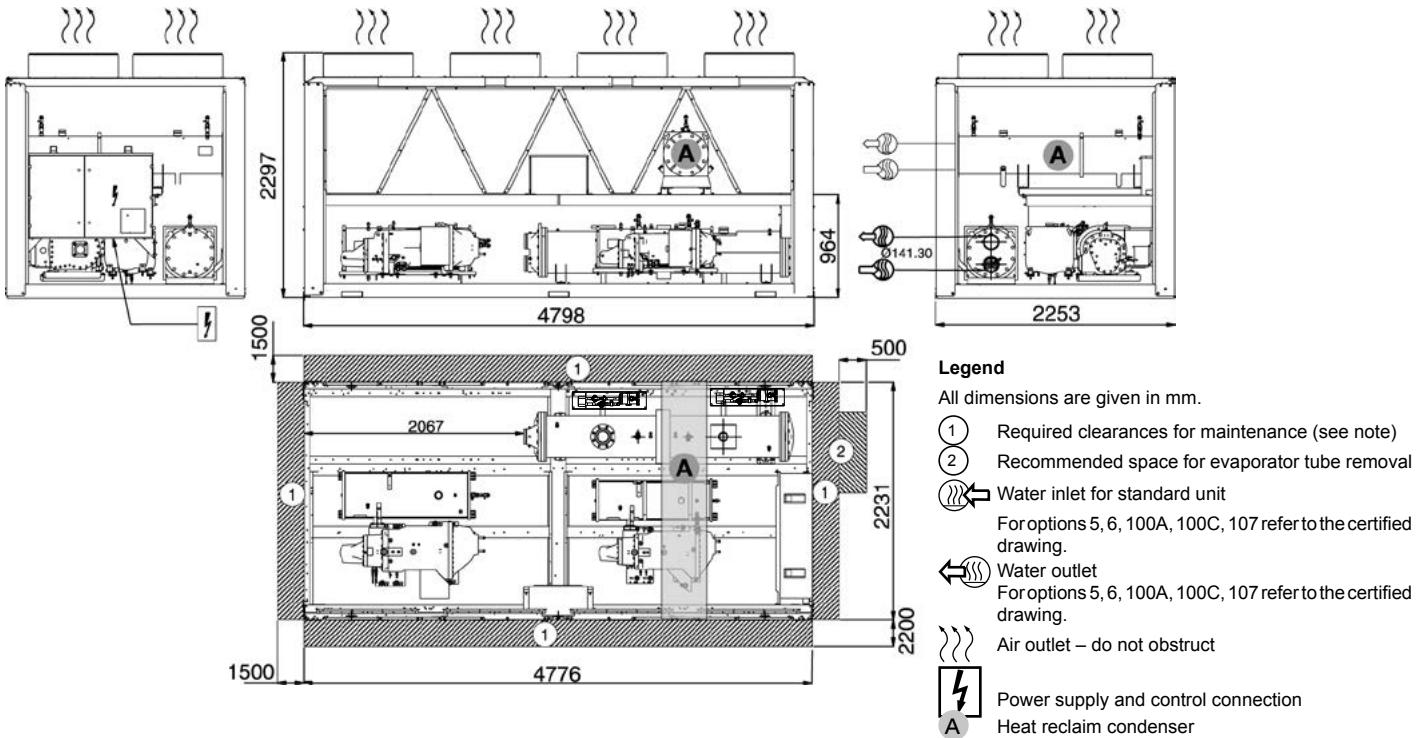

9.2.3 - 30XB-500 - heat reclaim option

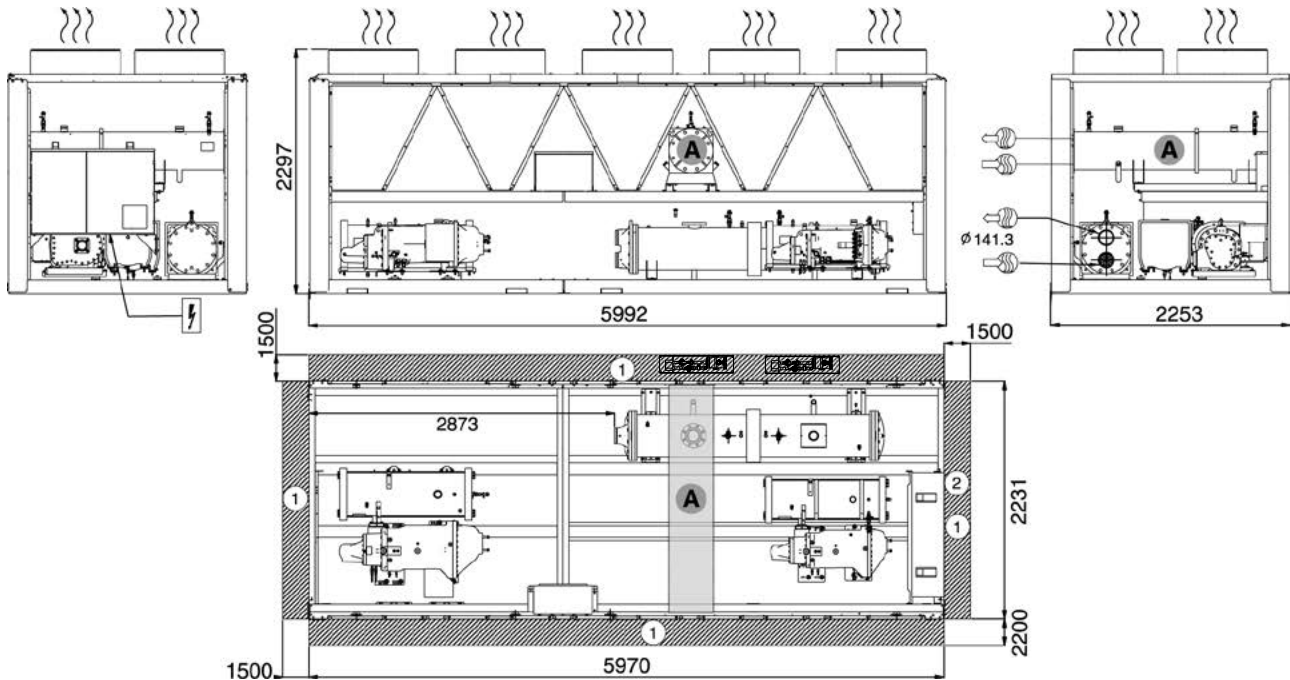

ATTENTION: The condenser connection sleeves are not installed, but supplied with the unit. The sealing joints are in the control box. The temperature sensors and the condenser flow switch are wired and fixed in the machine. They must be installed as described in the chapter “Condenser water connections”.

NOTES:

- Drawings are not contractually binding.
- Before designing an installation, consult the certified dimensional drawings, available on request.
- For the positioning of the fixing points, weight distribution and centre of gravity coordinates please refer to the dimensional drawings.
- If the installation includes several units or if this (these) is (are) close to walls, please refer to chapters 3.11 - “Multiple chiller installation” and 3.12 - “Distance to the wall” of this document to determine the space required.

9 - HEAT RECLAIM CONDENSER OPTION (OPTION 50)

9.2.4 - 30XB-600 to 800 - heat reclaim option

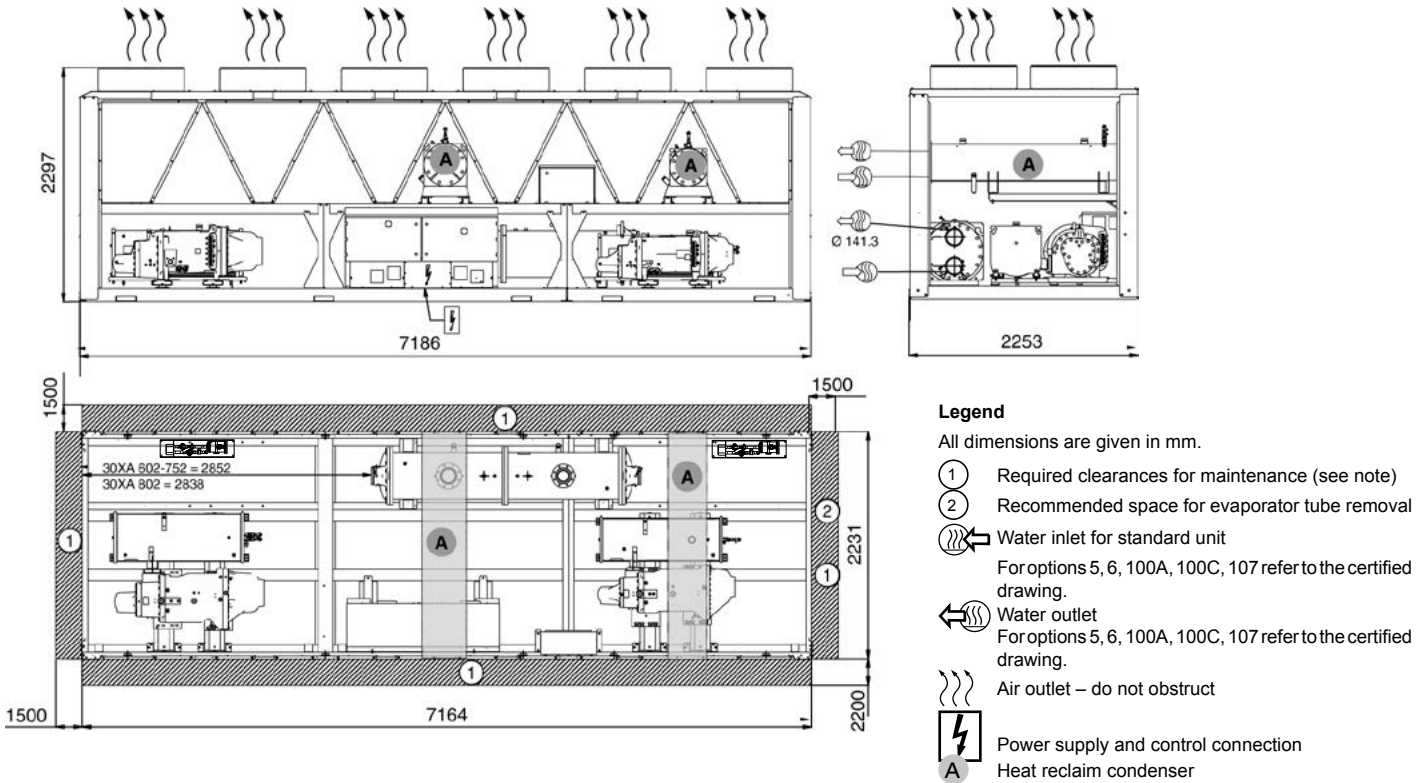

9.2.5 - 30XB-850 & 900 - heat reclaim option

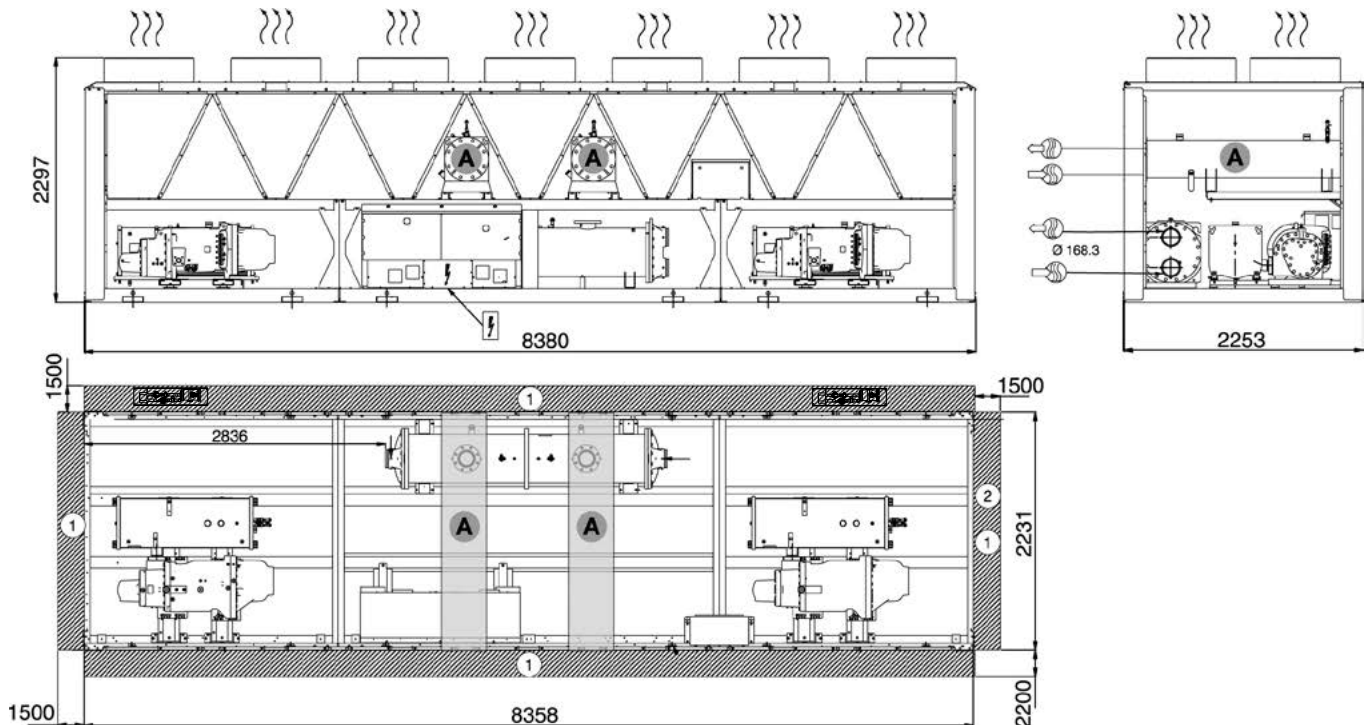

ATTENTION: The condenser connection sleeves are not installed, but supplied with the unit. The sealing joints are in the control box. The temperature sensors and the condenser flow switch are wired and fixed in the machine. They must be installed as described in the chapter “Condenser water connections”.

NOTES:

- Drawings are not contractually binding.
- Before designing an installation, consult the certified dimensional drawings, available on request.
- For the positioning of the fixing points, weight distribution and centre of gravity coordinates please refer to the dimensional drawings.
- If the installation includes several units or if this (these) is (are) close to walls, please refer to chapters 3.11 - “Multiple chiller installation” and 3.12 - “Distance to the wall” of this document to determine the space required.



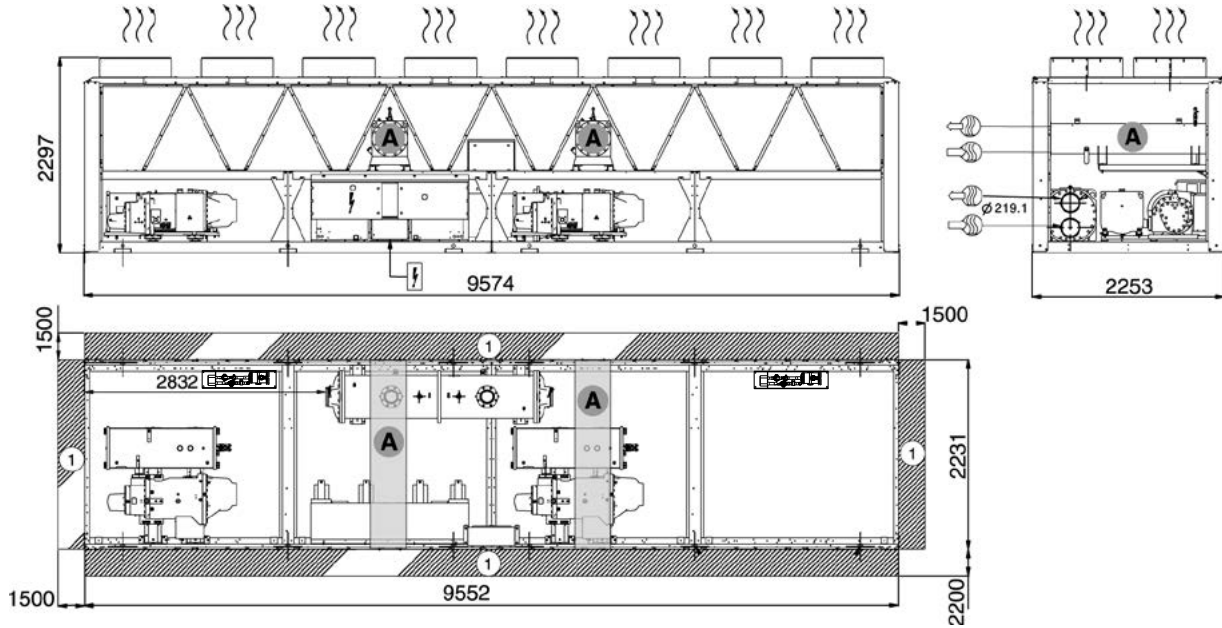

9 - HEAT RECLAIM CONDENSER OPTION (OPTION 50)

9.2.6 - 30XB-1000 - heat reclaim option



Legend

All dimensions are given in mm.

- ① Required clearances for maintenance (see note)
- ② Recommended space for evaporator tube removal
-  Water inlet for standard unit
 For options 5, 6, 100A, 100C, 107 refer to the certified drawing.
-  Water outlet
 For options 5, 6, 100A, 100C, 107 refer to the certified drawing.
-  Air outlet – do not obstruct
-  Power supply and control connection
-  Heat reclaim condenser

ATTENTION: The condenser connection sleeves are not installed, but supplied with the unit. The sealing joints are in the control box. The temperature sensors and the condenser flow switch are wired and fixed in the machine. They must be installed as described in the chapter “Condenser water connections”.

NOTES:

- Drawings are not contractually binding.
- Before designing an installation, consult the certified dimensional drawings, available on request.
- For the positioning of the fixing points, weight distribution and centre of gravity coordinates please refer to the dimensional drawings.
- If the installation includes several units or if this (these) is (are) close to walls, please refer to chapters 3.11 - “Multiple chiller installation” and 3.12 - “Distance to the wall” of this document to determine the space required.

9 - HEAT RECLAIM CONDENSER OPTION (OPTION 50)

9.3 - Condenser location

All heat reclaim condensers are located between the air-cooled condensers on the upper part of the chassis, supported by two cross rails. The water inlet and outlet are on the same side.

9.4 - Condenser water connections

9.4.1 - Unit with one heat reclaim condenser (30XB-250 to 500)

The water flow switch must be installed at the water inlet of the installation that arrives at the heat reclaim condenser.

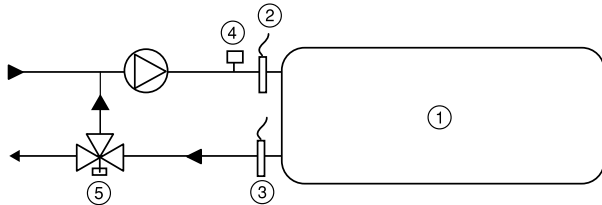

Legend

- 1 Heat reclaim condenser
- 2 Entering water temperature sensor (supplied)
- 3 Leaving water temperature sensor (supplied)
- 4 Condenser water flow switch (supplied)
- 5 Three-way valve (not supplied)

9.4.2 - Unit with two heat reclaim condensers (30XB-600 to 1000)

The two condensers must be installed in parallel in the water system of the installation. The water flow switch and the entering/leaving water temperature sensors must be installed in the line that is common to both heat reclaim circuits and as close as possible to the condensers. A T-piece must be provided by the installer at the water inlet and outlet of the condensers.

For units with two condensers the maximum cable length of the temperature sensors and the flow switch (7.5 m) is designed to allow connection to the common inlet or outlet in a radius of 4.5 m after routing along the width of the unit.

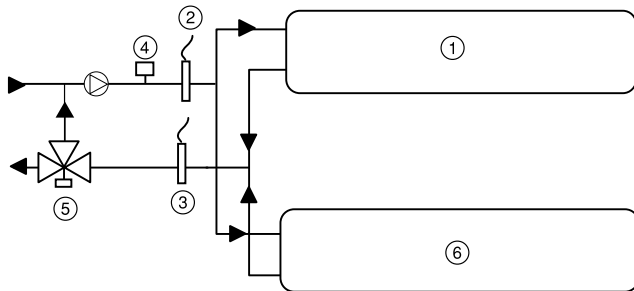

Legend

Please refer to the legend in chapter 9.4.1 opposite, noting that items 2, 3 and 4 - flow switch and sensors - are placed on the common sections.

9.4.3 - Three-way valves

It is strongly recommended to install a three-way valve in the system (not supplied with the unit). A 0-10 V output is available on the unit electronic board to control this valve. The valve allows bypassing of the heat reclaim condenser entering/leaving circuit to ensure unit operation with heat reclaim at low entering water temperature (< 12.5 °C). It also ensures an optimal and controlled leaving water temperature.

9.5 - Operating limits for stable operation (no mode changeover)

9.5.1 - Cooling only mode

Please refer to the earlier chapters in this manual:

- 6.1 - Unit operating range
- 6.7 - Evaporator water flow rate

9.5.2 - Heat reclaim mode

Condenser water temperature		
°C	Minimum	Maximum
Water entering temperature at start-up	12.5*	55
Water entering temperature during operation	20	55
Water leaving temperature during operation	25	60
Evaporator water temperature		
°C	Minimum	Maximum
Water entering temperature at start-up	-	45
Water entering temperature during operation	6.8	21
Water leaving temperature during operation	3.3	15

* The water entering temperature at start-up must not be lower than 12.5 °C. For installations with a lower temperature a three-way valve must be used.

NOTE: If the temperature at the evaporator is below 4 °C, a glycol/water solution or the frost protection option must be used.

In part-load operation, the limitation of the condenser leaving water temperature is due to the operating range of the screw compressor. If the condenser leaving water temperature is above the limit value given in the curves below, the unit will automatically change over to the mode without heat recovery:

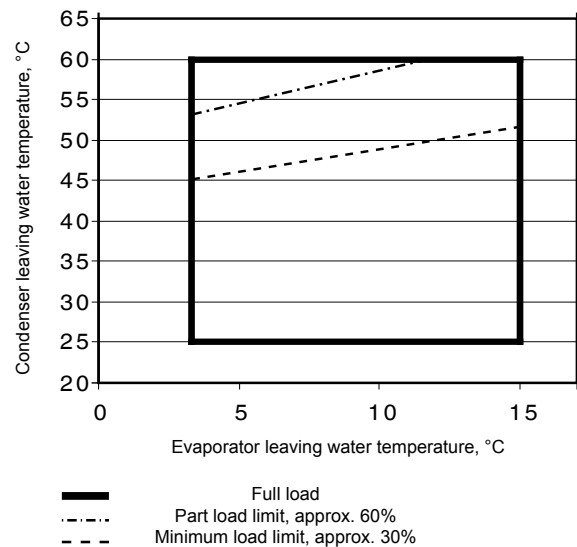

Part load operating limits (evaporator leaving water temperature = 7 °C)

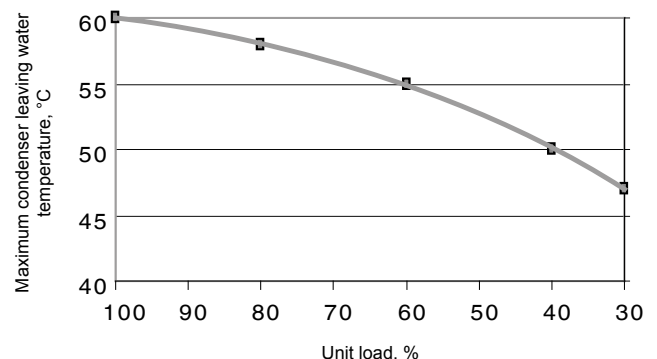

9.6 - Operating limits for changeover between modes

From cooling only to heat reclaim and vice versa.

Heat reclaim condenser water temperature		
°C	Minimum	Maximum
Water entering temperature	12.5	57.5
Ambient operating temperature	-10*	45

* -20 °C with winter operation option (option 28)

9 - HEAT RECLAIM CONDENSER OPTION (OPTION 50)

9.7 - Flow control

The water flow switch supplied needs to be installed at the heat reclaim condenser water inlet and protects the condenser loop against low water flow conditions. When the heat reclaim mode is required, a signal from the additional board output activates the system pump. Once the pump is started, flow detection takes place for one minute. If no flow is detected by the end of this time:

1. Changeover to the heat reclaim mode is not permitted
2. Mode is changed to cooling only mode when the water flow rate is low, accompanied by a water flow detection alarm.

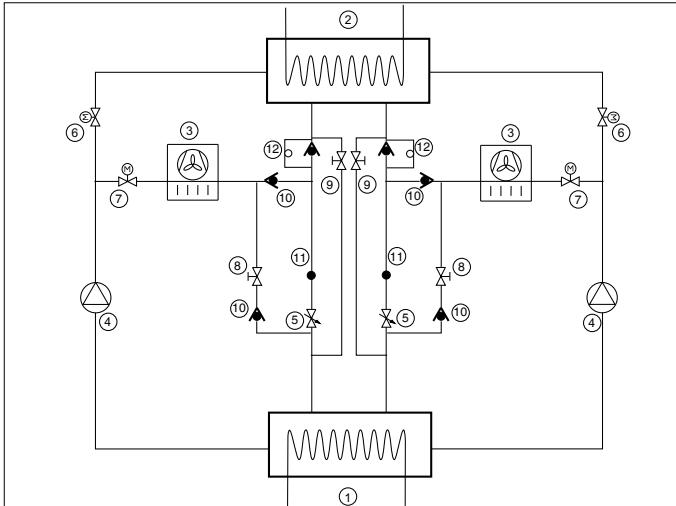

Legend

- 1 Evaporator
- 2 Heat reclaim condenser
- 3 Air condenser (coils)
- 4 Compressor
- 5 Expansion device (EXV)
- 6 Motorised valve - heat reclaim mode
- 7 Motorised valve - cooling only mode
- 8 Solenoid valve - charge recovery in heat reclaim mode
- 9 Solenoid valve - charge recovery in cooling only mode
- 10 Check valve
- 11 Pressure and temperature measurement to calculate the liquid sub-cooling to optimise the charge recovery
- 12 Check valve with capillary

9.8 - Heat reclaim operation

The heat reclaim condenser option is only available on units with two circuits. It has been designed with one or two single or two-circuit shell-and-tube heat exchangers, depending on the unit size.

The two circuits are independently controlled. One circuit can be in cooling only and the other in heat reclaim mode.

Changeover from one mode to the other (changeover from heat exchange at the air condenser to heat exchange at the water condenser and vice versa) is ensured by motorised two-way valves located upstream of the air and water condensers.

ATTENTION: Mode changes may lead to higher sound levels than the levels at stable operation.

Depending on the mode selected (heat reclaim or cooling), the logic compares the water entering temperature required with the setpoint. Depending on this difference the unit circuits are either activated or deactivated in heat reclaim mode (one or two together), as shown in the following diagram and table.

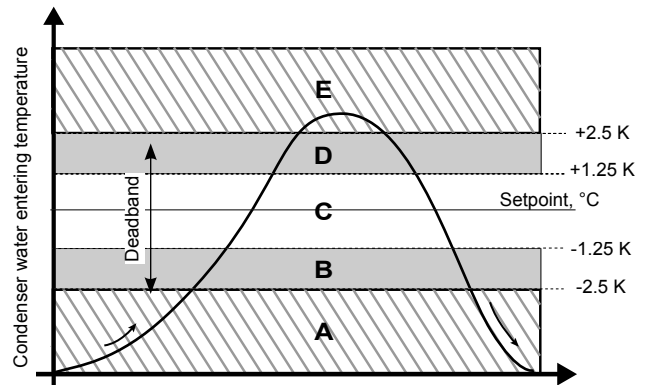

The deadband of 5 K is controlled by default.

Case	Selection of the heat reclaim mode	Number of circuits in heat reclaim mode	Action
-	NO	0	+ 2 circuits in cooling mode
A	YES	Whatever the number	+ 2 circuits in heat reclaim mode
B	YES	0	+ 1 circuit in heat reclaim mode
		1	No change
		2	No change
C	YES	Whatever the number	No change
D	YES	1	No change
		2	- 1 circuit in heat reclaim mode
E	YES	Whatever the number	- 2 circuits in heat reclaim mode

For more details on the heat reclaim operation logic please refer to the 30XB/30XAS/30XW Touch Pilot control manual, chapter 6.15 - "Optional heat reclaim module".

9.9 - Condenser pump selection

Heat reclaim condenser water flow rate/pressure drop

Heat reclaim condenser pressure drop in water flow rate function

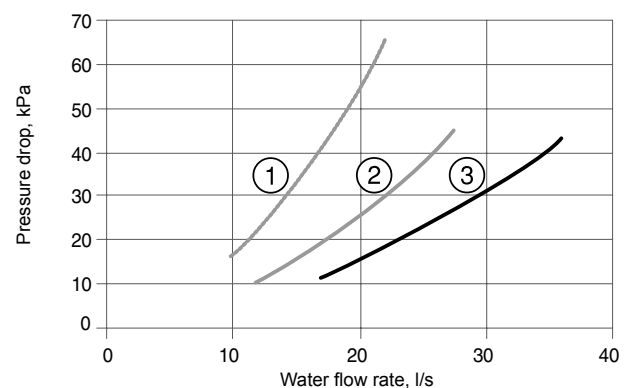

- 1 Condenser 10" (water volume = 38 litres)
- 2 Condenser 12" (water volume = 55 litres)
- 3 Condenser 14" (water volume = 68 litres)

For units with a water condenser please refer to chapter 9.1 - "Technical data, 30XB units with heat reclaim condenser option".

9.10 - Frost protection

The heat reclaim condenser is equipped with electric heaters to protect the condenser against frost. These are activated if the condenser entering and leaving water temperatures are below 3 °C and deactivated, if they are higher than 4.3 °C.

10 - FANS WITH AVAILABLE PRESSURE (OPTION 10)

If this option has been selected, the fans with available pressure are equipped with discharge connection flanges to facilitate the duct connection.

NOTE: Each fan must be individually ducted.

11 - MAJOR SYSTEM COMPONENTS AND OPERATION DATA

11.1 - Direct-drive twin-screw compressor with variable capacity slide valve

- 30XB units use 06T geared twin-screw compressors equipped with a variable capacity slide valve for continuous control between 30% and 100% of full load.
- Nominal capacities range from 120 to 750 kW. The ten models used in the 30XB & XBP range are economised.

11.1.1 - Oil filter

The 06T screw compressor has an independent oil filter attached to the oil separator. This filter is field replaceable.

11.1.2 - Refrigerant

The 30XB & XBP range units can operate with R-134a & R1234Ze refrigerants.

11.1.3 - Lubricant

The 06T screw compressor is approved for use with the following lubricants:

- Castrol Icematic SW220 (Carrier specification PP47-32)
- Lubrizol Emkarate RL220H (Carrier specification PP47-13).

11.1.4 - Oil supply solenoid valve

An oil supply solenoid valve is installed on the oil return line as standard to isolate the compressor from oil flow when the compressor is not operating. The oil solenoid valve is field replaceable.

11.1.5 - Suction and economizer screens

To increase the reliability of the compressor, a screen has been incorporated as a standard feature into suction and economizer inlets of the compressor.

11.1.6 - Capacity control system

The 06T screw compressor has an unloading system that is standard on all compressors. This unloading system consists of slide valve that permits changing the length of the screw used for the refrigerant compression. This valve is controlled by the action of a piston controlled by two solenoid valves on the oil return line.

11.2 - Pressure vessels

General

Monitoring during operation, re-qualification, re-testing and re-testing dispensation:

- Follow the regulations on monitoring pressurised equipment.
- It is normally required that the user or operator sets up and maintains a monitoring and maintenance file.
- If there are no regulations or to complement them follow the control programmes of EN 378.
- If they exist follow local professional recommendations.
- Regularly inspect the condition of the coating (paint) to detect blistering resulting from corrosion. To do this, check a non-insulated section of the container or the rust formation at the insulation joints.
- Regularly check for possible presence of impurities (e.g. silicon grains) in the heat exchange fluids. These impurities maybe the cause of the wear or corrosion by puncture.
- Filter the heat exchange fluid check and carry out internal inspections as described in EN 378.
- In case of re-testing please refer to the maximum operating pressure given on the unit nameplate.
- The reports of periodical checks by the user or operator must be included in the supervision and maintenance file.

Repair

Any repair or modification, including the replacement of moving parts:

- Must follow local regulations and be made by qualified operators and in accordance with qualified procedures, including changing the heat exchanger tubes.
- Must be made in accordance with the instructions of the original manufacturer. Repair and modification that necessitate permanent assembly (soldering, welding, expanding etc.) must be made using the correct procedures and by qualified operators.
- An indication of any modification or repair must be shown in the monitoring and maintenance file.

Recycling

The unit is wholly or partly recyclable. After use it contains refrigerant vapours and oil residue. It is coated by paint.

Operating life

This unit is designed for:

- Prolonged storage of 15 years under nitrogen charge with a temperature difference of 20 K per day.
- 452000 cycles (start-ups) with a maximum difference of 6 K between two neighbouring points in the vessel, based on 6 start-ups per hour over 15 years at a usage rate of 57%.

Corrosion allowances:

Gas side: 0 mm

Heat exchange fluid side: 1 mm for tubular plates in lightly alloyed steels, 0 mm for stainless steel plates or plates with copper-nickel or stainless steel protection.

11.2.1 - Evaporator

30XB chillers use a flooded multi-tube evaporator. The water circulates in the tubes and the refrigerant is on the outside in the shell. One vessel is used to serve both refrigerant circuits. There is a centre tube sheet which separates the two refrigerant circuits. The tubes are 3/4" diameter copper with an enhanced surface inside and out. There is just one water circuit, and depending on the size of the chiller, there may be one, two or three water passes.

The units have three refrigerant circuits with two evaporators connected in series on the heat transfer fluid.

The evaporator has a thermal insulation of 19 mm thick polyurethane foam, an aluminium sheet (option) and is equipped with a water drain and purge.

The water connection of the heat exchanger is a Victaulic connection. As an option the evaporator is available with frost protection (evaporator frost protection option).

The products that may be added for thermal insulation of the containers during the water piping connection procedure must be chemically neutral in relation to the materials and coatings to which they are applied. This is also the case for the products originally supplied by Carrier.

11 - MAJOR SYSTEM COMPONENTS AND OPERATION DATA

11.2.2 - Oil separator

In these units, the oil separator is a pressure vessel that is mounted under the outside vertical condenser coils. Dis-charge gas at the compressor outlet is directed towards the bottom of the oil separator ring and most of the oil separates from the gas by strong deceleration and by gravity. The gas then flows through a wire mesh screen where the remaining oil is separated by coalescence and flows to the bottom of the ring. The gas is now free from oil and leaves the ring at the top towards the condenser.

The oil separator is equipped with a trace heater regulated by the control.

11.2.3 - Economiser function

The economiser function includes a liquid line valve, a filter drier, two EXVs, a plate heat exchanger as well as protection devices (fuse or valve).

At the condenser outlet a part of the liquid is expanded via the secondary EXV in one of the heat exchanger circuits and then returns as gas at the compressor economiser. This expansion permits increase of the liquid sub-cooling of the rest of the flow that penetrates the evaporator via the principal EXV. This permits increasing the cooling capacity of the system as well as its efficiency.

11.3 - High-pressure safety switch

30XB units are equipped with high-pressure safety switches.

In accordance with the applicable code the high-pressure switches with manual reset, called PZH (former DBK), may be backed up by high-pressure switches that require resetting with a tool. The high-pressure switches that require resetting with a tool are called PZHH (former SDBK). If a PZHH cuts out, the corresponding PZH in the same com-pressor is faulty and must be replaced. The PZHH must be reset with a blunt tool with a diameter of less than 6 mm. Insert this tool into the opening on the pressure switch and push the reset button in this location.

These pressure switches are located at the discharge of each compressor.

11.4 - Condensers

30XB coils are all-aluminium micro-channel condensers. Optional coils with internally grooved copper tubes with aluminium fins are also available (options 254 and 255).

11.5 - Fans

The fans are axial Flying Bird fans equipped with rotating shroud and made of composite recyclable material. Each motor is fixed with transverse supports. The motors are three-phase, with permanently lubricated bearings and insulation class F (level IP55).

According to the Regulation No. 327/2011 implementing Directive 2009/125/EC with regard to ecodesign requirements for fans driven by motors with an electric input power between 125 W and 500 kW.

30XB		30XB Standard	30XB Option 15LS	30XBP
Overall efficiency	%	38,7	35,3	47,3
Measurement category		A	A	A
Afficiency category		static	static	static
Target efficiency level ERP2015		N(2015) 40	N(2015) 40	N(2015) 40
Efficiency level at optimum efficiency point		43,3	42,1	52,2
Variable speed drive		NO	NO	YES (embedded)
year of manufacture		See label on the unit	See label on the unit	See label on the unit
Fan manufacturer		Simonin	Simonin	Simonin
Motor manufacturer		Leroy Somer	Leroy Somer	EBM Papst
Fan PN		00PSG002630700	00PSG002630700	00PSG002630700
Motor PN		00PPG000478400A	00PPG000478500A	00PSG002696800A
Nominal power of the motor	kW	1,9	0,85	1,68
Flow rate	m ³ /s	4,22	3,1	4,24
Pressure at optimum energy efficiency	Pa	174,2	96,7	174,6
Nominal speed	rpm	949	710	959
specifica ratio		1,002	1,002	1,002
Relevant information to facilitate the disassembly, recycling or removal of the product at the end of life		See the maintenance manual	See the maintenance manual	See the maintenance manual
Relevant information to minimise the impact on the environment		See the maintenance manual	See the maintenance manual	See the maintenance manual

11 - MAJOR SYSTEM COMPONENTS AND OPERATION DATA

According to the Regulation No. 640/2009 and amendment 4/2014 implementing Directive 2009/125/EC with regard to ecodesign requirements for electric motors.

30XB		30XB Standard	30XB Option 15LS	30XBP
Motor type		Asynchronous	Asynchronous	EC motor
Number of poles		6	8	6
Nominal input frequency	Hz	50	50	50/60
Nominal voltage	V	400	400	380/480
number of phases		3	3	3
Motor included in the application domain of the regulation 640/2009 and amendment 4/2014		No	No	NO
Rationale for exemption		Article 1.2.c).(ii)	Article 2.1	Article 2.1
Ambient air temperature for which the motor is specifically designed	°C	70	70	70

11.6 - Electronic expansion valve (EXV)

The EXV is equipped with a stepper motor (2785 to 3690 steps, depending on the model) that is controlled via the EXV board. The EXV is also equipped with a sightglass that permits verification of the mechanism movement and the presence of the liquid gasket.

11.7 - Moisture indicator

Located on the EXV, permits control of the unit charge and indicates moisture in the circuit. The presence of bubbles in the sight-glass indicates an insufficient charge or non-con-densables in the system. The presence of moisture changes the colour of the indicator paper in the sight-glass.

11.8 - Filter drier

The role of the filter drier is to keep the circuit clean and moisture-free. The moisture indicator shows, when it is necessary to change the element. A difference in temperature between the filter inlet and outlet shows that the element is dirty.

11.9 - Sensors

The units use thermistors to measure the temperature, and pressure transducers to control and regulate system operation. Refer to the 30XB/30XAS/30XW Touch Pilot control manual for a more detailed explanation.

11.10 - Service valve (option 92)

The unit can be equipped with optional service valves to facilitate maintenance and repair operations.

If option 92 is ordered, each refrigerant circuit will be supplied with shut-off valves on the compressor economiser, discharge and suction lines.

ATTENTION: The compressor suction valve must be used without pressure difference at the terminals. If there is a pressure difference, leak-tightness at the valve may be lost and the valve can even fail altogether.

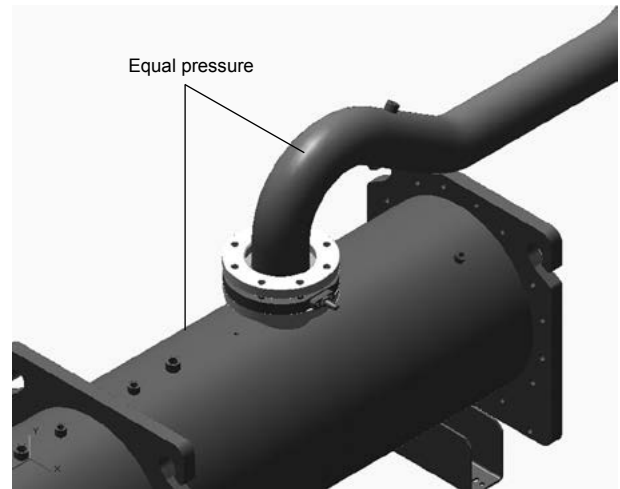

11.11 - Power factor correction capacitors (option 231)

They guarantee a minimum power factor performance of 0.95 when unit operates at a condition that involves a power input that exceeds the Eurovent standard condition.

A fix capacitor bank is switched at start of each compressor. It provides individual power factor correction for each machine refrigerant circuit.

Capacitors are dry type : no risk of leakage or fire.

The capacitors are selected for each compressor as per below table:

Compressor	Capacitor (kVAR)	Ir (A)
06TSA155	15	22
06TSA186	20	29
06TTA266	35	51
06TTA301	35	51
06TTA356	35	51
06TUA483	45	65
06TUA554	45	65

Caution: Operation of the unit without capacitors results in current raising

11 - MAJOR SYSTEM COMPONENTS AND OPERATION DATA

30XB fan arrangement

30XB & XBP-250 to 350

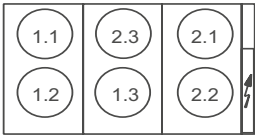

30XB-900 (option 254/255)

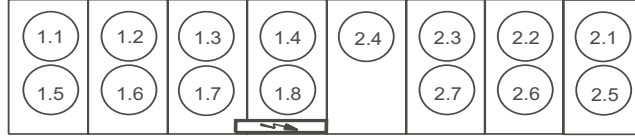

30XB-350 (option 254-255)

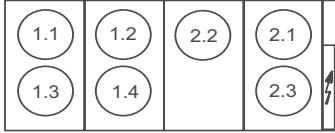

30XBP-1000 & 30XB-1550 module 1

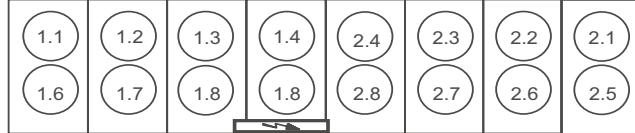

30XB & XBP-400 & 450, 30XB-500

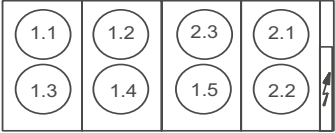

30XB-1100

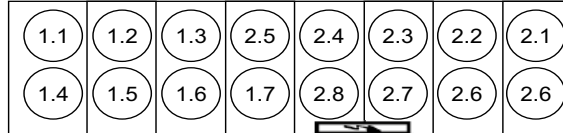

30XB-500 (option 254/255, 50, 118) 30XBP-500

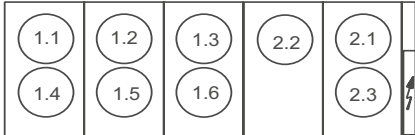

30XB-1200

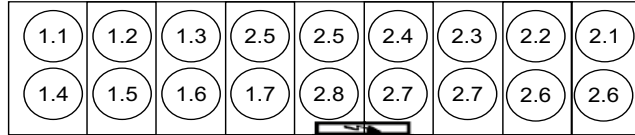

30XB & XBP-600

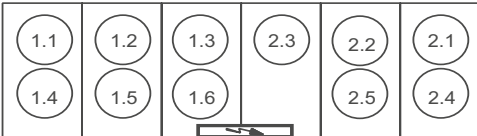

30XBP-1100, 30XB-1100 (option 254/255)

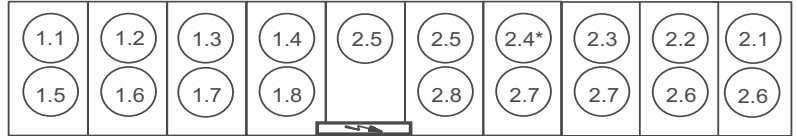

30XB & XBP-700, 30XB-900

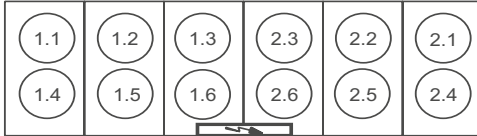

30XBP-1200, 30XB-1200 (option 254/255)

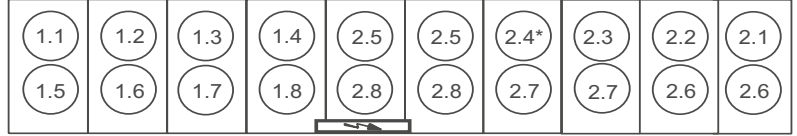

30XB & XBP-750 to 850, 30XB-850

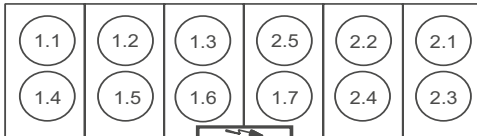

30XB & XBP-1300 to 1400

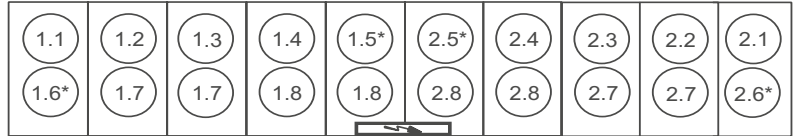

30XBP-900 & 30XB-900 (option 50 & 118), 30XB-1000

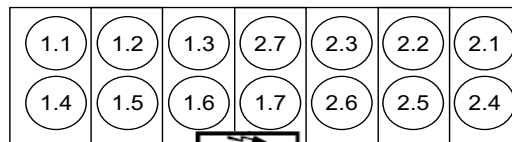

30XB & XBP-1500

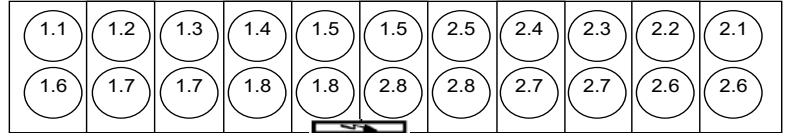

30XB-850 (option 50 & 118), 30XBP-850, 30XB-750 & 800 (option 254/255), 30XB-1700 Module 1 et 2

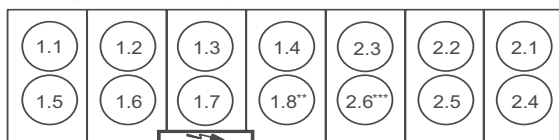

** not present on 802

*** not present on 752

NOTE: The values above do not correspond to the fan designation. The fan designation and position are given on the unit drawings and wiring diagrams supplied with the unit.

* These fans are also used to reduce the ventilation steps during change-over of dual stages: They may stop and then restart depending on the stage ordered.

x = Circuit number

y = Start-up order

12 - MAIN OPTIONS

Options	No.	Description	Advantages	Use for 30XB/XBP range
Coil with anti-corrosion post treatment	2B	Factory application of Blygold Polual treatment on the copper/aluminum coils	Improved corrosion resistance, recommended for industrial, rural and marine environments	30XB/30XBP 250-1700
Corrosion protection, traditional coils	3A	Fins made of pre-treated aluminum (polyurethane and epoxy)	Improved corrosion resistance, recommended for moderate marine and urban environments	30XB/30XBP 250-1700
Medium-temperature brine solution	5	Implementation of new algorithms of control and evaporator redesign to allow chilled brine solution production down to -6°C when ethylene glycol is used (-3°C with propylene glycol)	Covers specific applications such as ice storage and industrial processes	30XB/30XBP 250-1700
Low-temperature brine solution	6	Implementation of new algorithms of control and evaporator redesign to allow chilled brine solution production down to -12°C when ethylene glycol is used (-8°C with propylene glycol)	Covers specific applications such as ice storage and industrial processes	30XB/30XBP 250-1700
Light-brine solution, down to -3°C	8	Implementation of new algorithms of control to allow chilled brine solution production down to -3°C when ethylene glycol is used (0°C with propylene glycol)	Matches with most application requirements for ground-sourced heat pumps and fits with many industrial processes requirements	30XB/30XBP 250-1700
Unit equipped for air discharge ducting	10	Fans equipped with discharge connection flanges - maximum available pressure 60 Pa	Facilitates connections to the discharge ducts	30XB/30XBP 250-1700
Low noise level	15	Aesthetic and sound absorbing compressor enclosure	Noise level reduction by 1 to 2 dB(A)	30XB/30XBP 250-1700
Very low noise level	15LS	Aesthetic and sound absorbing compressor enclosure associated with low-speed fans	Noise level reduction for sensible site	30XB/30XBP 250-1700
Ultra low noise level	15LS+	Acoustic compressor enclosure, low-speed fans and enhanced sound insulation of main noise sources	Noise level reduction for sensible site	30XB 250-1700
Variable speed fans	17	Unit equipped with variable speed fans	Enhances the unit seasonal energy efficiency performance and reduces the noise emission thanks to a smooth fan speed variation.	30XB 250-1700
IP54 control box	20A	Increased leak tightness of the unit	Protects the inside of the electrical box from dusts, water and sand. In general this option is recommended for installations in polluted environments	30XB/30XBP 250-1700
Tropicalisation of the electrical box	22	Electrical box equipped with an electrical heater and a fan. Electrical connections on the compressors painted with a special varnish and covered with an anti-condensation foam.	Grant safe operation in typical "tropical" climate. This option is recommended for all applications where humidity inside the electrical box can reach 80% at 40°C and unit can remain in stand-by for a long time under this conditions.	30XB/30XBP 250-1700
Grilles and enclosure panels	23	Metal grilles on the 4 unit sides, plus side enclosure panels at each end of the coil	Improves aesthetics, protection against intrusion to the unit interior, coil and piping protection against impacts.	30XB/30XBP 250-1700
Enclosure panels	23A	Side enclosure panels at each end of the coil	Improves aesthetics, coil and piping protection against impacts.	30XB/30XBP 250-1700
Low inrush current	25C	Specific loading and unloading compressor sequence to limit the unit start-up current	Reduced start-up current	30XB/30XBP 250-1700
Winter operation down to -20°C	28	Fan speed control via frequency converter	Stable unit operation for air temperature down to -20°C	30XB 250-1700
Water exchanger frost protection	41A	Electric resistance heater on the water exchanger and discharge valve	water exchanger frost protection down to -20°C outside temperature	30XB/30XBP 250-1700
Evaporator & hydraulic module frost protection	41B	Electric resistance heater on water exchanger, discharge valve and hydraulic module	Water exchanger and hydraulic module frost protection down to -20°C outside temperature	30XB/30XBP 250-500
Total heat recovery	50	Unit equipped with additional heat exchanger in parallel with the condenser coils.	Production of free hot-water simultaneously with chilled water production	30XB/30XBP 250-1000
Master/slave operation	58	Unit equipped with supplementary water outlet temperature sensor kit to be field-installed allowing master/slave operation of two units connected in parallel	Optimised operation of two units connected in parallel operation with operating time equalisation	30XB/30XBP 250-1500
Single power connection point	81	Unit power connection via one main supply connection	Quick and easy installation	30XB/30XBP 1100-1550
Service valve set	92	Liquid line valve (evaporator inlet), compressor suction and discharge line valves and economiser line valve	Allow isolation of various refrigerant circuit components for simplified service and maintenance	30XB/30XBP 250-1700
Compressor discharge valves	93A	Shut-off valve on the compressor discharge piping	Simplified maintenance	30XB/30XBP 250-1700
Evaporator with one pass more	100A	Evaporator with one pass more on the water side	Optimise chiller operation when the chilled water circuit is designed with low waterflows (high delta T evaporator inlet/outlet)	30XB/30XBP 250-1700
Evaporator with one pass less	100C	Evaporator with one pass on the water side. Evaporator inlet and outlet on opposite sides.	Easy to install, depending on site. Reduced pressure drops	30XB/30XBP 250-1000
21 bar evaporator	104	Reinforced evaporator for extension of the maximum water-side service pressure to 21 bar (standard 10 bar)	Covers applications with a high water column evaporator side (typically high buildings)	30XB/30XBP 250-1700
Reversed evaporator water connections	107	Evaporator with reversed water inlet/outlet	Easy installation on sites with specific requirements	30XB/30XBP 250-1700
HP single-pump hydraulic module	116B	Complete hydraulic module equipped with water filter, expansion tank with relief valve, one high pressure pump, drain valve and water flow control valve. For more details, refer to the dedicated chapter	Easy and fast installation (plug & play). Increased system reliability	30XB/30XBP 250-500
HP dual-pump hydraulic module	116C	Complete hydraulic module equipped with water filter, expansion tank with relief valve, two high pressure pumps, drain valve and water flow control valve. For more details, refer to the dedicated chapter	Easy and fast installation (plug & play). Increased system reliability	30XB/30XBP 250-500

12 - MAIN OPTIONS

Options	No.	Description	Advantages	Use for 30XB/XBP range
LP single-pump hydraulic module	116F	Complete hydraulic module equipped with water filter, expansion tank with relief valve, one low pressure pump, drain valve and water flow control valve. For more details, refer to the dedicated chapter	Easy and fast installation (plug & play). Increased system reliability	30XB/30XBP 250-500
LP dual-pump hydraulic module	116G	Complete hydraulic module equipped with water filter, expansion tank with relief valve, two low pressure pumps, drain valve and water flow control valve. For more details, refer to the dedicated chapter	Easy and fast installation (plug & play). Increased system reliability	30XB/30XBP 250-500
Dx Free Cooling system on two circuits	118A	Patented Carrier free-cooling system with cooling micro-pump on both refrigerant circuits. Operation without glycol, no extra free-cooling coil. See Dx Free-cooling option chapter	Energy savings for applications with cooling demand throughout the entire year	30XB/30XBP 250-1000
J-Bus gateway	148B	Two-directional communication board complying with JBus protocol	Connects the unit by communication bus to a building management system	30XB/30XBP 250-1700
Lon gateway	148D	Two-directional communication board complying with Lon Talk protocol	Connects the unit by communication bus to a building management system	30XB/30XBP 250-1700
Bacnet over IP	149	Two-directional high-speed communication using Bacnet protocol over Ethernet network (IP)	Easy and high-speed connection by ethernet line to a building management system. Allows access to multiple unit parameters	30XB/30XBP 250-1700
Energy Management Module	156	EMM Control board with additional inputs/outputs. See Energy Management Module option chapter	Extended remote control capabilities (Set-point reset, ice storage end, demand limits, boiler on/off command...)	30XB/30XBP 250-1700
7" user interface	158A	Control supplied with a 7 inch colour touch screen user interface	Enhanced ease of use.	30XB/30XBP 250-1700
Input contact for Refrigerant leak detection	159	0-10 V signal to report any refrigerant leakage in the unit directly on the controller (the leak detector itself must be supplied by the customer)	Immediate customer notification of refrigerant losses to the atmosphere, allowing timely corrective actions	30XB/30XBP 250-1700
Dual relief valves on 3-way valve	194	Three-way valve upstream of the relief valves on the evaporator and the oil separator	Valve replacement and inspection facilitated without refrigerant loss. Comforms to European standard EN378/BGVD4	30XB/30XBP 250-1000
Compliance with Swiss regulations	197	Additional tests on the water heat exchangers: supply (additional of PED documents) supplementary certificates and test certifications	Conformance with Swiss regulations	30XB/30XBP 250-1700
Compliance with Russian regulations	199	EAC certification	Conformance with Russian regulations	30XB/30XBP 250-1700
Compliance with Australian regulations	200	Unit approved to Australian code	Conformance with Australian regulations	30XB/30XBP 250-1700
Power factor correction	231	Capacitors for automatic regulation of power factor (cos phi) value to 0,95.	Reduction of the apparent electrical power, compliance with minimum power factor limit set by utilities	30XB/30XBP 250-1000
Traditional coils (Cu/Al)	254	Coils made of copper tubes with aluminum fins	None	30XB 250-1700 (not available for size 1500)
Traditional coils (Cu/Al) without slots	255	Coils made of copper tubes with aluminum fins without slots	None	30XB 250-1700 (not available for size 1500)
Insulation of the evap. in/ out ref.lines	256	Thermal insulation of the evaporator entering/leaving refrigerant lines with flexible, anti-UV insulant	Prevents condensation on the evaporator entering/leaving refrigerant lines	30XB/30XBP 250-1700
Enviro-Shield anti-corrosion protection	262	Coating by conversion process which modifies the surface of the aluminum producing a coating that is integral to the coil. Complete immersion in a bath to ensure 100% coverage. No heat transfer variation, tested 4000 hours salt spray per ASTM B117	Improved corrosion resistance, recommended for use in moderately corrosive environments	30XB/30XBP 250-1700
Super Enviro-Shield anti-corrosion protection	263	Extremely durable and flexible epoxy polymer coating applied on micro channel heat exchangers by electro coating process, final UV protective topcoat. Minimal heat transfer variation, tested 6000 hours constant neutral salt spray per ASTM B117, superior impact resistance per ASTM D2794	Improved corrosion resistance, recommended for use in extremely corrosive environments	30XB/30XBP 250-1700
Welded evaporator connection kit	266	Victaulic piping connections with welded joints	Easy installation	30XB/30XBP 250-1700
Compressor enclosure	279a	Compressor enclosure	Improved aesthetic, compressor protection against external aggressions (dust, sand, water...)	30XB/30XBP 250-1700
Evaporator with aluminum jacket	281	Evaporator covered with an aluminum sheet for thermal insulation protection	Improved resistance to aggressive climate conditions	30XB/30XBP 250-1700
230V electrical plug	284	230V AC power supply source provided with plug socket and transformer (180 VA, 0,8 Amps)	Permits connection of a laptop or an electrical device during unit commissioning or servicing	30XB/30XBP 250-1700
Carrier Connect link (only European distributor company)	298	3G router board NOTE 1: require option 149 NOTE 2: when more than one machine is installed on site, only one of them shall be equipped with option 298 while all of them must be equipped with option 149 NOTE 3: if the Carrier® PlantCTRL™ is on site, option 298 shall be integrated in the Carrier® PlantCTRL™ while option 149 is still mandatory for each single unit.	Enabler for Carrier Connect service offer	30XB/30XBP 250-1700
Compliance with UAE regulation	318	Additional label on the unit with rated power input, rated current and EER following AHRI 550/590	Compliance with ESMA standard UAE 5010-5 :2014.	30XB/30XBP 250-1700
Compliance with Qatar regulation	319	Specific nameplate on the unit with power supply 415 V+/-6%	Compliance with KAHRAMAA regulation in Qatar.	30XB/30XBP 250-1700

13 - STANDARD MAINTENANCE

Air conditioning equipment must be maintained by professional technicians, whilst routine checks can be carried out locally by specialised technicians. See the standard EN 378-4.

Simple preventive maintenance will allow you to get the best performance from your HVAC unit:

- Improved cooling performance
- Reduced power consumption
- Prevention of accidental component failure
- Prevention of major time-consuming and costly interventions
- Protection of the environment.

There are five maintenance levels for HVAC units, as defined by the AFNOR X60-010 standard.

13.1 - Level 1 maintenance

See note "Any deviation or non-observation ..." in chapter 13.3 - "Level 3 (or higher) maintenance". Simple procedure can be carried out by the user:

- Visual inspection for oil traces (sign of a refrigerant leak)
- Air heat exchanger (condenser) cleaning - see chapter 13.6.1 - "Level 1".
- Check for removed protection devices, and badly closed doors/covers
- Check the unit alarm report when the unit does not work. Refer to the 30XB/30XAS/30XW Touch Pilot control manual for a more detailed explanation.

General visual inspection for any signs of deterioration.

13.2 - Level 2 maintenance

See note "Any deviation or non-observation ..." in the ext column. This level requires specific know-how in the electrical, hydraulic and mechanical fields. It is possible that these skills are available locally: Existence of a maintenance service, industrial site, specialised subcontractor. In these cases, the following maintenance operations are recommended.

Carry out all level 1 operations, then:

- At least once a year tighten the power circuit electrical connections (see table 13.4).
- Check and re-tighten all control/command connections, if required (see table 13.4).
- Check the differential switches for correct operation every 6 months (free-cooling option 118A).
- Remove the dust and clean the interior of the control boxes, if required.
- Check the presence and the condition of the electrical protection devices.
- Check the correct operation of all heaters.
- Replace the fuses every 3 years or every 15000 hours (age-hardening).
- Replace the control box cooling fans used with option 22 (with designation EF22_) every five years.
- Check the height of the anti-vibration mountings (located between the compressor rails and the unit chassis) after 5 years of operation, and then each year. When the total minimum height of the mountings is less than 25 mm replace the mountings.
- Check the water connections.
- Purge the water circuit.
- Clean the water filter.
- Fully clean the condensers with a low-pressure jet and a bio-degradable cleaner (counter-current cleaning - see chapter 13.6.2 - "Level 2").
- Replace the stuffing box packing of the pump after 10000 hours of operation.

- Check the unit operating parameters and compare them with previous values.
- Keep and maintain a maintenance sheet, attached to each HVAC unit.
- Check the correct operation of the capacitor (power factor correction option 231).

All these operations require strict observation of adequate safety measures: Individual protection garments, compliance with all industry regulations, compliance with applicable local regulations and using common sense.

13.3 - Level 3 (or higher) maintenance

NOTE: Any deviation or non-observation of these maintenance criteria will render the guarantee conditions for the HVAC unit null and void, and the manufacturer, Carrier SCS will no longer be held responsible.

The maintenance at this level requires specific skills/approval/tools and know-how and only the manufacturer, his representative or authorised agent are permitted to carry out these operations. These maintenance operations concern for example:

- A major component replacement (compressor, evaporator)
- Any intervention on the refrigerant circuit (handling refrigerant)
- Changing of parameters set at the factory (application change)
- Removal or dismantling of the HVAC unit
- Any intervention due to a missed established maintenance operation
- Any intervention covered by the warranty.

13.4 - Tightening torques for the main electrical connections

13.4.1 - Tightening torques for the main electrical connections

Screw type	Use	Value (N.m)
(N.m)		
Metal screw D = 4.8	Condensing module, housing supports	4,2
Screw H M8	Condensing module, compressor fixing	18
Taptite screw M10	Condensing module, chassis - structure fixing, control box fixings, compressor fixings, oil separator fixing	30
Taptite screw M6	Piping support, cowling	7
Screw H M8	Piping clip	12
Screw H M6	Piping clip	10
Nut H M10	Compressor chassis	30
Nut H M10	Hydraulic pump chassis	30
Screw H M8	Filter drier cover	35
Screw H M12	Economiser port flange	40
Screw H M16	Oil separator flanges, suction flanges	110
Screw H M16	Heat exchanger water boxes	190
Screw H M20	Suction flanges	190
Nut 5/8 ORFS	Oil line	65
Nut 3/8 ORFS	Oil line	26
Nut H M12/M16	Victaulic collars on suction piping	60/130
Self-locking Nut M16	Compressor fixing	30

ATTENTION: The tightening of the connections at the compressor terminals requires special precautions. Please refer to the chapter below.

13 - STANDARD MAINTENANCE

13.4.2 - Connection precautions for the compressor power terminals

These precautions must be applied during an intervention that requires the removal of the power conductors connected to the compressor supply terminals.

The tightening nut of terminal (6) supporting the isolator (7) must never be loosened, as it ensures terminal tightness and compressor leak tightness.

The tightening of phase lug (4) must apply the torque between counter nut (5) and tightening nut (3): During this operation a counter-torque must be applied at counter nut (5). Counter-nut (5) must not be in contact with the tightening nut of terminal (6).

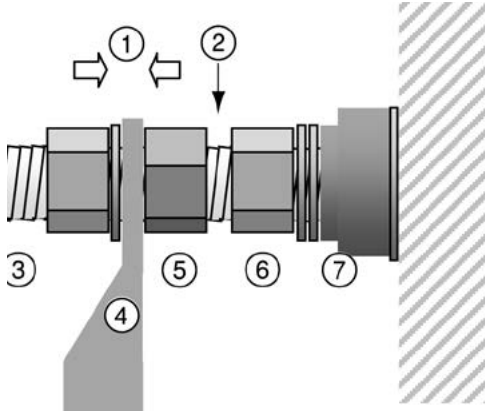

1. Torque application to tighten the lug
2. Avoid contact between the two nuts
3. Lug tightening nut
4. Flat lug
5. Counter-nut
6. Terminal tightening nut
7. Isolator

13.5 - Tightening torques for the main bolts and screws

Screw type	Use	Value (N.m)
(N.m)		
Metal screw D = 4.8	Condensing module, housing supports	4,2
Screw H M8	Condensing module, compressor fixing	18
Taptite screw M10	Condensing module, chassis - structure fixing, control box fixings, compressor fixings, oil separator fixing	30
Taptite screw M6	Piping support, cowling	7
Screw H M8	Piping clip	12
Screw H M6	Piping clip	10
Nut H M10	Compressor chassis	30
Nut H M10	Hydraulic pump chassis	30
Screw H M8	Filter drier cover	35
Screw H M12	Economiser port flange	40
Screw H M16	Oil separator flanges, suction flanges	110
Screw H M16	Heat exchanger water boxes	190
Screw H M20	Suction flanges	190
Nut 5/8 ORFS	Oil line	65
Nut 3/8 ORFS	Oil line	26
Nut H M12/M16	Victaulic collars on suction piping	60/130
Self-locking Nut M16	Compressor fixing	30

ATTENTION: The tightening of the connections at the compressor terminals requires special precautions. Please refer to the chapter below.

13.6 - Condenser coil

We recommend, that coils are inspected regularly to check the degree of fouling. This depends on the environment where the unit is installed, and will be worse in urban and industrial installations and near trees that shed their leaves.

For coil cleaning, two maintenance levels are used, based on the AFNOR X60-010 standard:

13.6.1 - Level 1

13.6.1.1 - Recommendations for maintenance and cleaning of round tube plate fin (RTPF) condenser coils

- Regular cleaning of the coil surface is essential for correct unit operation. Eliminating contamination and removal of harmful residue will increase the operating life of the coils and the unit.
- The maintenance and cleaning procedures below are part of the regular maintenance and will prolong the life of the coils.

Removal of fibres that obstruct the surfaces

Fibres and dirt collected on the coil surface must be removed with a vacuum cleaner. If you do not have a vacuum cleaner, a soft brush with non-metallic bristles can be used instead. In all cases cleaning must be done in the direction of the fins, as the coil surface is easily damaged. The fins bend easily and damage the protective coating of the coil, if cleaning is done at right angles to the fins. Clean against the air flow direction.

NOTE: Using a water jet from a spray hose on a polluted surface will result in fibres and dirt becoming trapped in the coil, making cleaning more difficult. All fibres and dirt must be removed from the surface, before using a low-speed rinsing jet.

Periodical cleaning with clean water:

For coils installed in a coastal or industrial environment periodical cleaning by rinsing with water is beneficial. It is however essential that rinsing is done with a low-speed water jet to avoid damaging the fins. Monthly cleaning as described below is recommended.

ATTENTION

- **Chemical cleaning agents, water containing bleach, acidic or basic cleaning agents must never be used to clean the coil exterior or interior. These cleaning agents may be difficult to rinse off and can accelerate corrosion at the joint between tube and fins, where two different materials come into contact.**
- **High-speed water from a high-pressure cleaner, spray hose or compressed air cleaner must never be used for coil cleaning. The force of the water or air jet will bend the fins and increase the air-side pressure drop. This can result in reduced performance or nuisance shutdowns of the unit.**

13.6.1.2 - Recommendations for maintenance and cleaning of MCHE (microchannel) condenser coils

- Regular cleaning of the coil surface is essential for correct unit operation. Eliminating contamination and removal of harmful residue will increase the operating life of the coils and the unit.
- The maintenance and cleaning procedures below are part of the regular maintenance and will prolong the life of the coils.

ATTENTION: Do not use chemical cleaners on MCHE condenser coils. These cleaning agents can accelerate corrosion and damage the coils.

- Remove foreign objects and debris attached to the coil surface or wedged between the chassis and the supports.

13 - STANDARD MAINTENANCE

- Provide personal protection equipment including safety glasses and/or a face mask, waterproof clothing and safety gloves. It is recommended to wear clothing that covers the whole body.
- Start the high-pressure spray gun and remove any soap or industrial cleaner from it before cleaning the condenser coils. Only drinkable cleaning water is permitted to clean the condenser coils.
- Clean the condenser face by spraying the coil evenly and in a stable manner from bottom to top, directing the water jet at right angles to the coil. Do not exceed 6200 kPa (62 bar) or an angle of 45° related to the coil. The diffuser must be at least 300 mm away from the coil surface. It is essential to control the pressure and to be careful not to damage the fins.

ATTENTION: Excessive water pressure can break the weld points between the fins and the flat MCHC microchannel tubes.

13.6.2 - Level 2

Clean the coil, using appropriate products. We recommend cleaning with clear water to remove pollutants. If the use of cleaning products is necessary, we specify:

- pH between 7 and 8
- Absence of chlorine, sulphate, copper, iron, nickel or titanium
- Chemical compatibility with aluminium and copper.

For RTPF coils this process can either be carried out using a high-pressure spray gun in the low-pressure position. With pressurised cleaning methods care should be taken not to damage the coil fins.

The spraying of the coil must be done:

- In the direction of the fins
- In the opposite direction of the air flow direction
- With a large diffuser (25-30°)
- At a minimum distance of 300 mm from the coil.

It is not necessary to rinse the coil, as the products used are pH neutral. To ensure that the coil is perfectly clean, we recommend rinsing with a low water flow rate.

For MCHC condenser coils refer to chapter 13.6.1.2 under level 1 maintenance for use of a high-pressure spray gun.

IMPORTANT:

- **Never use pressurised water without a large diffuser. Do not use high-pressure cleaners for Cu/Cu and Cu/Al coils! High pressure cleaners are only permitted for MCHC coils (maximum permitted pressure 6200 kPa (62 bar)).**
- **Concentrated and/or rotating water jets are strictly forbidden.**
- **Never use a fluid with a temperature above 45 °C to clean the air heat exchangers.**
- **Correct and frequent cleaning (approximately every three months) will prevent 2/3 of the corrosion problems.**
- **Protect the control box during cleaning operations.**

13.7 - Evaporator maintenance

Check that:

- The insulating foam is intact and securely in place.
- The cooler heaters are operating, secure and correctly positioned.
- The water-side connections are clean and show no sign of leakage.

13.8 - Compressor maintenance

13.8.1 - Oil separator

Check the correct operation of the heaters and check that they are well attached to the oil separator ring.

13.8.2 - Integral oil filter change

As system cleanliness is critical to reliable system operation, there is a filter in the oil line at the oil separator outlet. The oil filter is specified to provide a high level of filtration (5 µm) required for long bearing life.

The filter should be checked after the first 500 hours of operation, and every subsequent 2000 hours. The filter should be replaced at any time when the pressure differential across the filter exceeds 200 kPa (2 bar).

The pressure drop across the filter can be determined by measuring the pressure at the filter service port and the oil pressure port. The difference in these two pressures will be the pressure drop across the filter, check valve, and solenoid valve. The pressure drop across the check valve and solenoid valve is approximately 40 kPa (0.4 bar), which should be subtracted from the two oil pressure measurements to give the oil filter pressure drop.

13.8.3 - Compressor rotation control

Correct compressor rotation is one of the most critical application considerations. Reverse rotation, even for a very short duration, damages the compressor.

The reverse rotation protection scheme must be able to determine the direction of rotation and stop the compressor within 300 ms. Reverse rotation is most likely to occur when-ever the wiring to the compressor terminals is disturbed.

To minimize the opportunity for reverse rotation, the following procedure must be applied. Rewire the power cables to the compressor terminal pin as originally wired.

For replacement of the compressor, a low pressure switch is included with the compressor. This low pressure switch should be temporarily installed as a hard safety on the high pressure part of the compressor. The purpose of this switch is to protect the compressor against any wiring errors at the compressor terminal pin. The electrical contact of the switch would be wired in series with the high pressure switch. The switch will remain in place until the compressor has been started and direction of rotation has been verified; at this point, the switch will be removed.

The switch that has been selected for detecting reverse rotation is Carrier part number HK01CB001. This switch opens the contacts when the pressure falls below 7 kPa. The switch is a manual reset type that can be reset after the pressure has once again risen above 70 kPa. It is critical that the switch be a manual reset type to preclude the compressor from short cycling in the reverse direction.

13 - STANDARD MAINTENANCE

13.9 - Precaution for compressor power supply bus bar connection

This note applies to units using power supply bus bars with riveted contact block at the level of the connection cages in the control box. During re-connection it is imperative to:

- Engage each bus bar in the cage up to the stop
- Ensure visually that the bus bars have good contact at the connection areas: There must not be any free movement between the bus bar and the connection area created by the fixing rivet of the contact block.

Connection of the contactor or current transformer

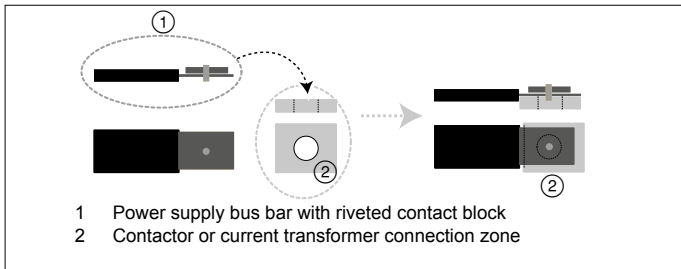

13.10 - Check of power factor correction capacitors

The verification consists in measuring input current of each capacitor bank. Check shall be done using a true RMS meter reading:

Ensure that the current draw through the capacitor is between 0.8 and 1.3x I_r. A higher value may indicate heavy presence of harmonics.

Absence of current despite capacitor is energized is an indication that there is a defect. Confirmation shall be done by removing the capacitors and checking the underside.

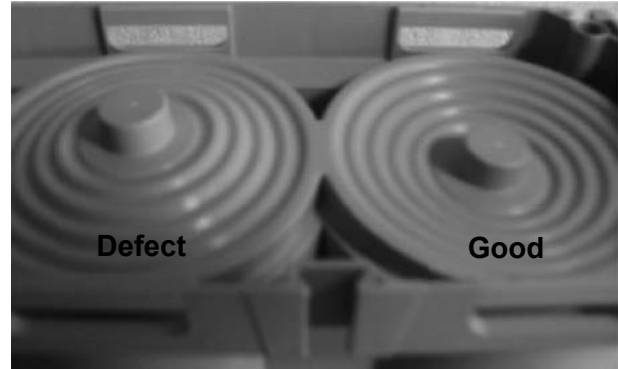

14 - START-UP CHECKLIST FOR 30XB LIQUID CHILLERS (USE FOR JOB FILE)

Preliminary information

Job name:
Location:
Installing contractor:
Distributor:

Unit

Model:

Compressors

Circuit A

Model number
Serial number
Motor number

Circuit B

Model number
Serial number
Motor number

Circuit C

Model number
Serial number
Motor number

Circuit D

Model number
Serial number
Motor number

Evaporator

Model number
Serial number

Condenser

Model number

Additional optional units and accessories
.....

Preliminary equipment check

Is there any shipping damage? If so, where?
.....
Will this damage prevent unit start-up?

- Unit is level in its installation
- Power supply agrees with the unit nameplate
- Electrical circuit wiring has been sized and installed properly
- Unit ground wire has been connected
- Electrical circuit protection has been sized and installed properly
- All terminals are tight
- All chilled water valves are open
- All chilled water piping is connected properly
- All air has been vented from the chilled water circuit
- Chilled water pump (CWP) is operating with the correct rotation. Check the phase sequence of the electrical connection. If the unit is equipped with a hydraulic module, use the pump test function. Refer to the 30XA/30XB/30XAS/30XW Touch Pilot control manual for a more detailed explanation.
- Circulate chilled water in the water circuit for at least two hours, then remove, clean and replace the screen filter. After the pump test has been completed, switch the unit off again.
- Inlet piping to cooler includes a 20 mesh strainer with a mesh size of 1.2 mm.
- The compressor flange has been removed.

14 - START-UP CHECKLIST FOR 30XB LIQUID CHILLERS (USE FOR JOB FILE)

Unit start-up

- a. Oil heaters have been energized for at least 24 hours
- b. Oil level is correct
- c. All discharge and liquid valves are open
- d. All suction valves are open, if equipped
- e. All oil line valves and economizer discharge bubbler valves (if equipped) are open
- f. The contactor
- g. Checks have been carried out for any possible leaks. Unit has been leak checked (including fittings)
 - g1 - on the whole unit
 - g2 - at all connectionsLocate, repair, and report any refrigerant leaks.....
.....
.....

- h. Check voltage imbalance: AB..... AC..... BC.....
Average voltage = V
Maximum deviation = V
Voltage imbalance = %

- i. Voltage imbalance is less than 2%

WARNING: Operation of the chiller with an improper supply voltage or excessive phase imbalance constitutes abuse and will invalidate the Carrier warranty. If the phase imbalance exceeds 2% for voltage, or 10% for current, contact your local electricity supply at once and ensure that the chiller is not switched on until corrective measures have been taken.

Check cooler water loop

- Water loop volume = litres
- Calculated volume = litres
- 3.25 litres/nominal kW capacity for air conditioning
- 6.5 litres/nominal kW capacity for process cooling
- Proper loop volume established
- Proper loop corrosion inhibitor included.....litres of.....
- Proper loop freeze protection included (if required) litres of.....
- Piping includes electric heater tape, if exposed to the outside
- Inlet piping to cooler includes a 20 mesh strainer with a mesh size of 1.2 mm

Check pressure drop across the cooler

- Entering cooler = kPa
- Leaving cooler = kPa
- Leaving - entering = kPa

WARNING: Plot cooler pressure drop on performance data chart (in product data literature) to determine total litres per second (l/s) and find unit's minimum flow rate.

- Total = l/s
- Nominal kW = l/s
- Total l/s is greater than unit's minimum flow rate
- Total l/s meets job specified requirement of..... l/s

WARNING: Once power is supplied to the unit, check for any alarms. Refer to the 30XB/30XAS/30XW Touch Pilot control manual for the alarm menu.

Note all alarms:.....
.....

Notes:.....
.....



Order No: 10224, 11.2017 - Supersedes order No: 10224, 09.2017.
Manufacturer reserves the right to change any product specifications without notice.

Manufacturer: Carrier SCS, Montluel, France.
Printed in the European Union.



Quality and Environment
Management Systems
Approval